

YOUR BEST THERMAL SOLUTIONS.

www.gulf.com.tw



GULF ELECTRICS was established in 1965 in Taiwan. Based on more than 50 years of experience in cooling industry, GULF has become the leader in manufacturing cooling fan & motor. With the commitment to our clients worldwide, we insist on not only every aspect of manufacturing, from material selection, analysis-based design, precise production, 100% quality control to customer-oriented service, but also through the continuous analysis and advanced technology to deliver product excellence.

Our wide product range includes AC/DC Axial fans and blowers, centrifugal fans, cross flow fans, outer rotor fans, thermal module and fan accessories, to provide you one-stop solution to fulfill all your cooling needs. All fans are made in Taiwan with high quality assurance and designed to meet UL, CE, RoHS and REACH requirements. Customization is also available including product specification and label & packaging design.

Our mission for the future is to continuously raise quality standard and keep optimizing product performance to **BE YOUR BEST THERMAL SOLUTIONS.**



AC Cross Flow Fans

GULF ELECTRICS CO., LTD

Latest Product Information: www.gulf.com.tw/en
+886-7-5219966 ; service@gulf.com.tw



JE-030A



General Specifications

Airflow	14~60 CFM
Static Pressure	0.8~1.7 mmAq
Housing	Black Zinc Electroplating
Blade	ALUMINUM ALLOY
Connecting	Wire Leads

Performance

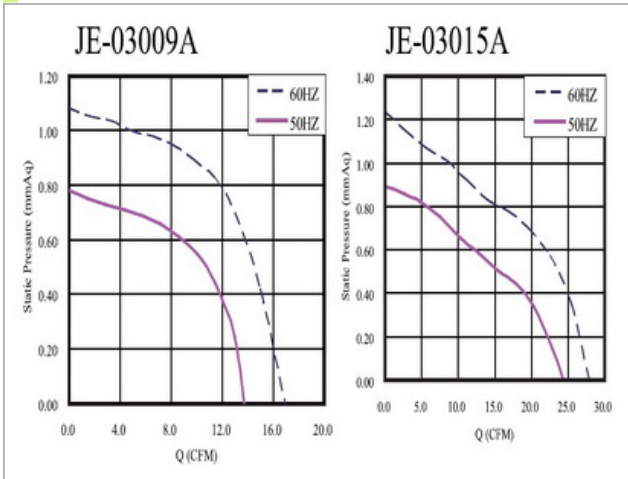

Performance

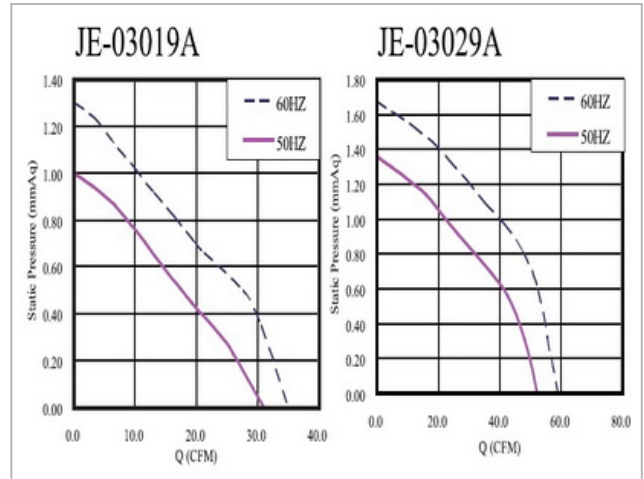

Dimensions:mm

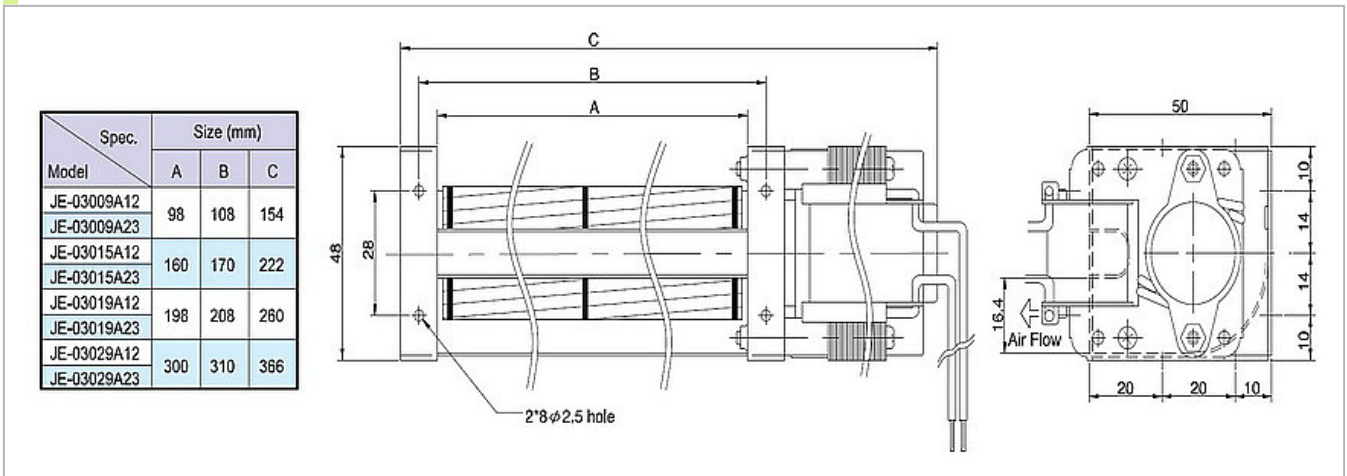

Specifications

Model NO.	Rated Voltage VAC	Frequency HZ	Speed RPM	Airflow CFM	Static Pressure mmAq	Current A	Power W	Noise dBA	Weight g
JE-03009A12	110/120	50/60	2500/2900	14/17	0.8/1.1	0.11/0.09	8/7	21/24	390
JE-03009A23	220/240	50/60	2500/2900	14/17	0.8/1.1	0.07/0.05	8/7	21/24	390
JE-03015A12	110/120	50/60	2700/3100	24/28	0.9/1.2	0.14/0.12	9/8	27/30	520
JE-03015A23	220/240	50/60	2700/3100	24/28	0.9/1.2	0.09/0.07	10/9	27/30	520
JE-03019A12	110/120	50/60	2700/3100	32/35	1.0/1.3	0.14/0.12	9/8	27/30	540
JE-03019A23	220/240	50/60	2700/3100	32/35	1.0/1.3	0.09/0.07	11/9	27/30	540
JE-03029A12	110/120	50/60	2700/3100	53/60	1.4/1.7	0.20/0.17	15/13	32/34	670
JE-03029A23	220/240	50/60	2700/3100	53/60	1.4/1.7	0.09/0.07	12/11	32/34	670

GULF ELECTRICS CO., LTD

Latest Product Information: www.gulf.com.tw/en
+886-7-5219966 ; service@gulf.com.tw



JE-040A



General Specifications

Airflow	21~74 CFM
Static Pressure	1.7~2.6 mmAq
Housing	Black Zinc Electroplating
Blade	ALUMINUM ALLOY
Connecting	Wire Leads

Performance

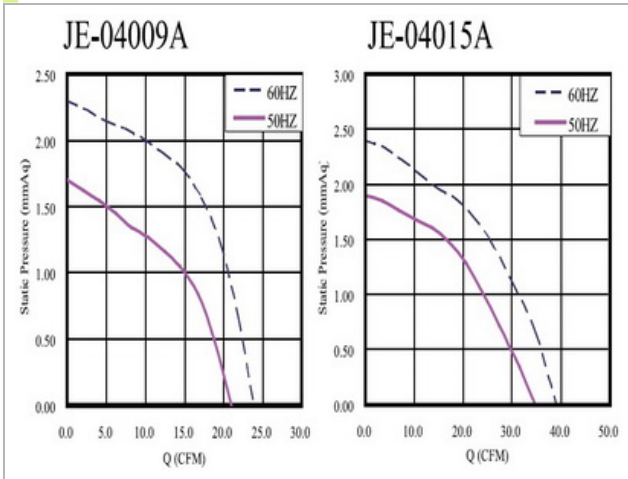

Performance

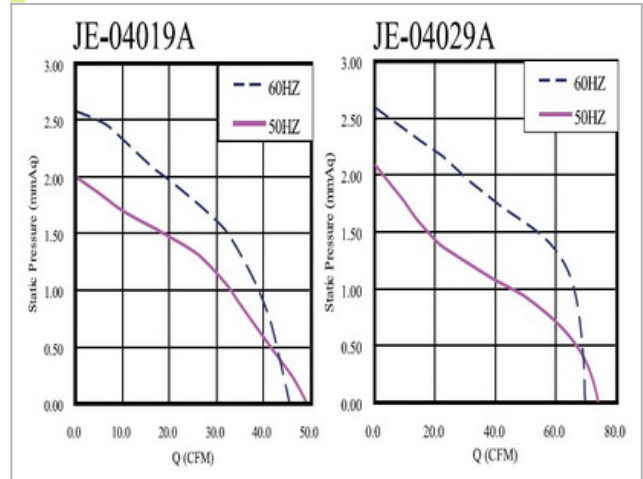

Dimensions:mm

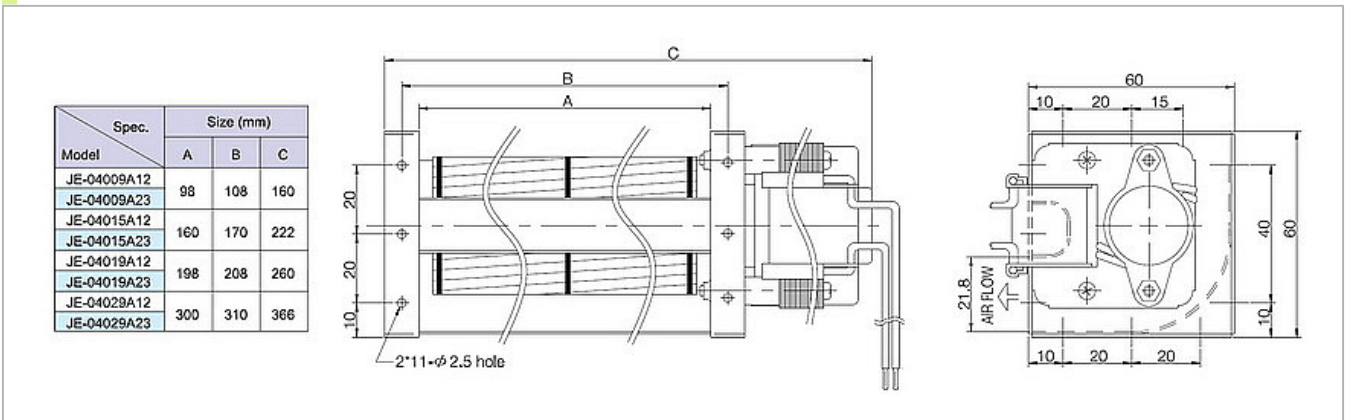

Specifications

Model NO.	Rated Voltage VAC	Frequency HZ	Speed RPM	Airflow CFM	Static Pressure mmAq	Current A	Power W	Noise dBA	Weight g
JE-04009A12	110/120	50/60	2700/3000	21/24	1.7/2.3	0.14/0.12	10/9	29/33	520
JE-04009A23	220/240	50/60	2700/3000	21/24	1.7/2.3	0.09/0.07	11/9	29/33	520
JE-04015A12	110/120	50/60	2600/2800	35/39	1.9/2.4	0.15/0.13	11/10	30/34	560
JE-04015A23	220/240	50/60	2600/2800	35/39	1.9/2.4	0.09/0.07	11/9	30/34	560
JE-04019A12	110/120	50/60	2500/2400	49/46	2.0/2.6	0.15/0.13	10/9	33/31	600
JE-04019A23	220/240	50/60	2500/2400	49/46	2.0/2.6	0.09/0.07	12/11	33/31	600
JE-04029A12	110/120	50/60	2400/2200	74/70	2.1/2.6	0.23/0.21	17/16	37/35	730
JE-04029A23	220/240	50/60	2400/2200	74/70	2.1/2.6	0.10/0.09	13/13	37/35	730

GULF ELECTRICS CO., LTD

Latest Product Information: www.gulf.com.tw/en
+886-7-5219966 ; service@gulf.com.tw



JM-040A



General Specifications



Airflow	1.3~2.0 m3/min
Static Pressure	0.6~0.8 mmAq
Housing	Aluminum
Blade	ALUMINUM ALLOY
Connecting	Wire Leads

Performance

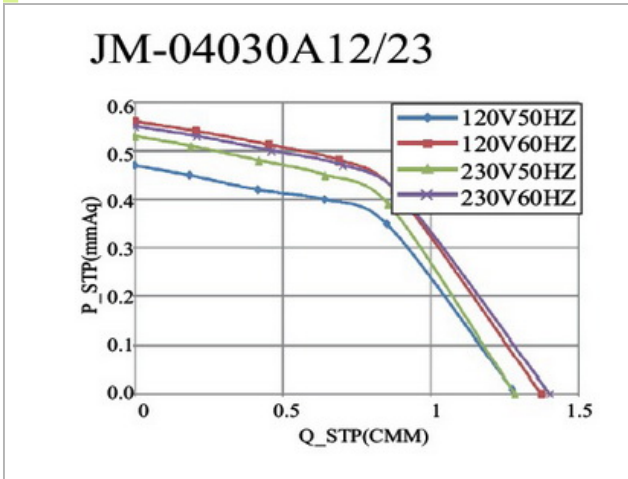

Performance

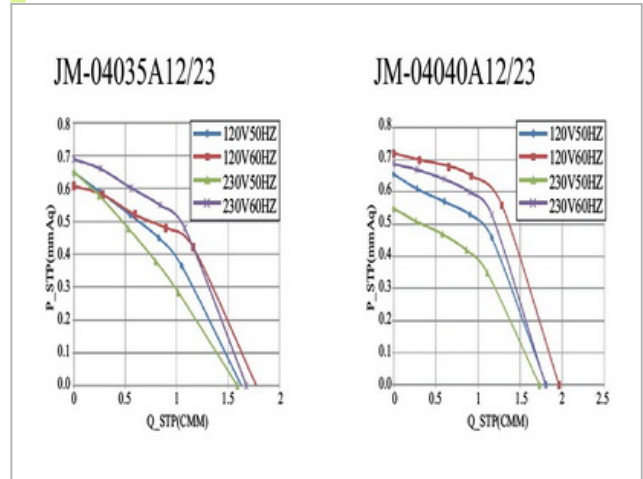

Dimensions:mm

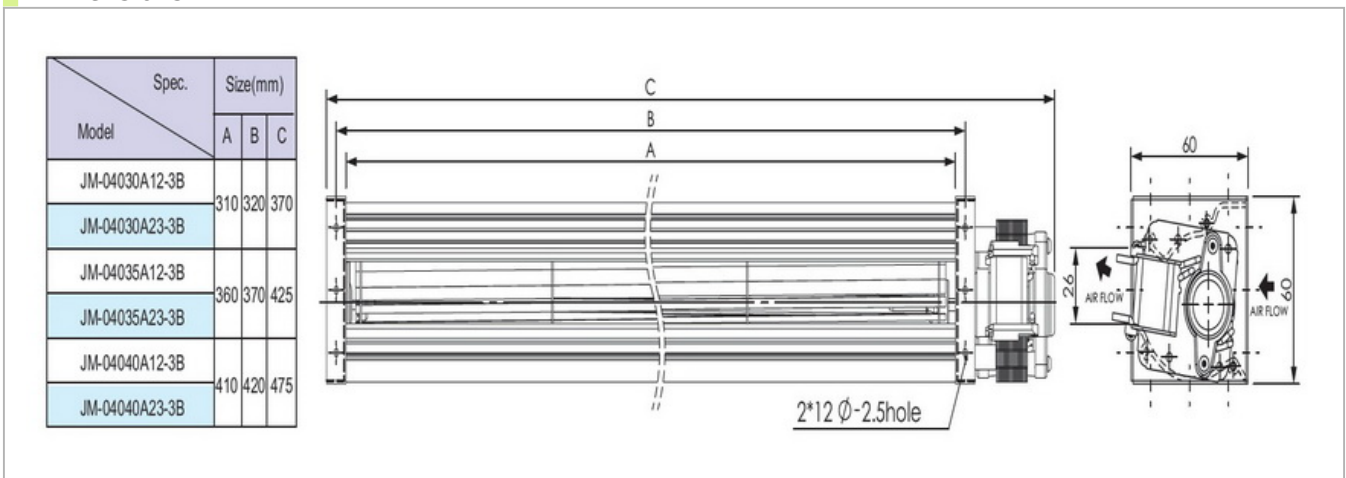

Specifications

Model NO.	Rated Voltage Frequency		Speed	Airflow	Static Pressure	Current	Power	Noise	Weight
	VAC	HZ							
JM-04030A12-3B	110/120	50/60	2600/2500	1.3/1.4	0.6/0.8	0.15/0.13	11/10	28/29	700
JM-04030A23-3B	220/240	50/60	2500/2700	1.3/1.4	0.6/0.8	0.09/0.08	14/13	28/30	700
JM-04035A12-3B	110/120	50/60	2600/2900	1.7/1.8	0.6/0.7	0.22/0.19	16/15	29/32	805
JM-04035A23-3B	220/240	50/60	2500/2700	1.6/1.7	0.6/0.7	0.09/0.08	13/12	28/30	805
JM-04040A12-3B	110/120	50/60	2600/2800	1.8/2.0	0.6/0.8	0.22/0.20	15/14	29/31	845
JM-04040A23-3B	220/240	50/60	2500/2600	1.7/1.8	0.6/0.7	0.09/0.08	13/12	28/29	845

GULF ELECTRICS CO., LTD

Latest Product Information: www.gulf.com.tw/en
+886-7-5219966 ; service@gulf.com.tw



JE-050A



General Specifications

Airflow	24~116 CFM
Static Pressure	2.7~4.3 mmAq
Housing	Black Zinc Electroplating
Blade	ALUMINUM ALLOY
Connecting	Wire Leads

Performance

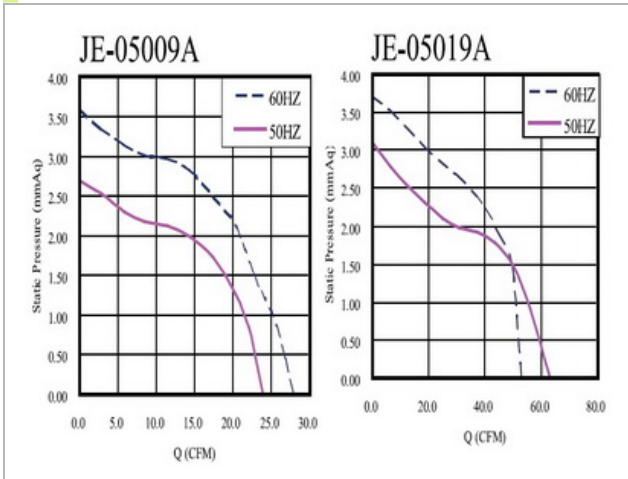

Performance

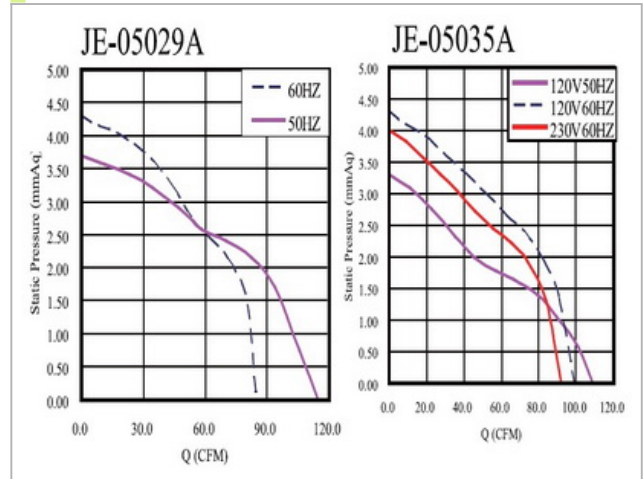

Dimensions:mm

Model	Size (mm)		
	A	B	C
JE-05009A12	98	108	162
JE-05009A23	98	108	162
JE-05019A12	198	208	267
JE-05019A23	198	208	267
JE-05029A12	298	308	377
JE-05029A23	298	308	377
JE-05035A12	358	368	437
JE-05035A23	358	368	437

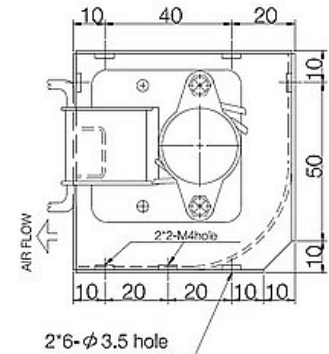
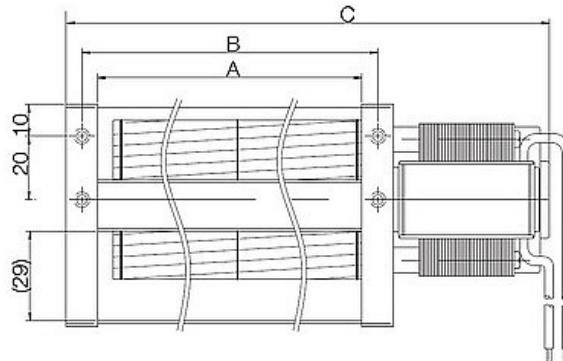

Specifications

Model NO.	Rated Voltage VAC	Frequency HZ	Speed RPM	Airflow CFM	Static Pressure mmAq	Current A	Power W	Noise dBA	Weight g
JE-05009A12	110/120	50/60	2500/2600	24/28	2.7/3.6	0.15/0.13	11/10	36/37	610
JE-05009A23	220/240	50/60	2500/2600	24/28	2.7/3.6	0.09/0.07	11/10	36/37	610
JE-05019A12	110/120	50/60	2200/1800	67/60	3.1/3.7	0.23/0.21	18/16	36/33	770
JE-05019A23	220/240	50/60	2100/1700	63/56	3.1/3.6	0.10/0.09	14/13	35/32	770
JE-05029A12	110/120	50/60	2300/2000	116/88	3.7/4.3	0.35/0.33	24/24	41/37	1100
JE-05029A23	220/240	50/60	2300/1800	116/81	3.7/4.1	0.15/0.14	21/20	41/35	1100
JE-05035A12	110/120	50/60	2300/2000	110/103	3.7/4.3	0.35/0.33	23/23	41/36	1200
JE-05035A23	220/240	50/60	2200/1600	110/92	3.5/4.0	0.15/0.14	20/19	40/34	1200

GULF ELECTRICS CO., LTD

Latest Product Information: www.gulf.com.tw/en
+886-7-5219966 ; service@gulf.com.tw



JM-050A



General Specifications

Airflow	1.2~3.4 m3/min
Static Pressure	1.1/1.7 mmAq
Housing	Aluminum
Blade	ALUMINUM ALLOY
Connecting	Wire Leads

Performance

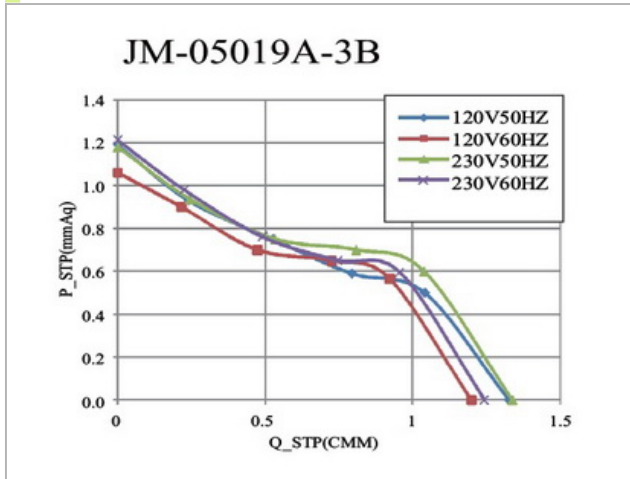

Performance

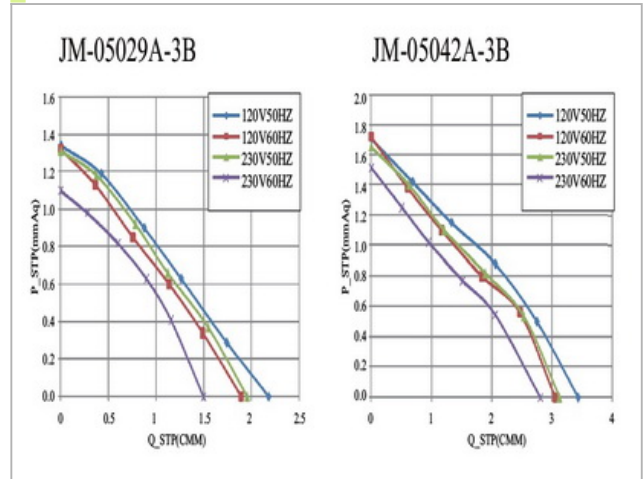

Dimensions:mm

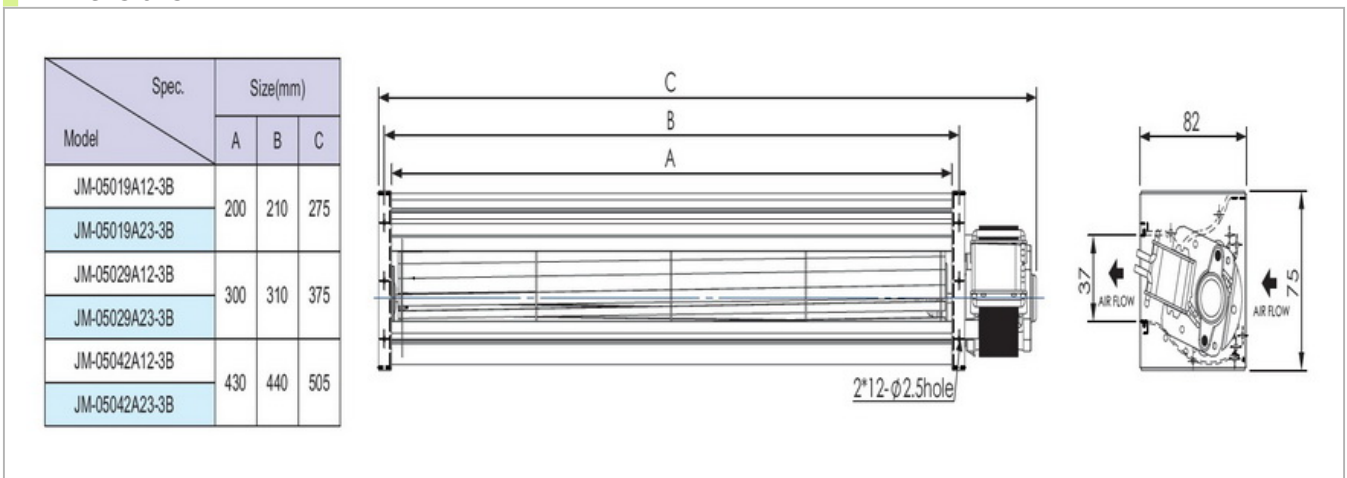

Specifications

Model NO.	Rated Voltage Frequency		Speed	Airflow	Static Pressure	Current	Power	Noise	Weight
	VAC	HZ							
JM-05019A12-3B	110/120	50/60	2200/2050	1.3/1.2	1.2/1.1	0.15/0.13	12/11	31/28	715
JM-05019A23-3B	220/240	50/60	2150/2050	1.3/1.2	1.2/1.2	0.08/0.07	13/12	30/28	715
JM-05029A12-3B	110/120	50/60	2250/2050	2.2/1.9	1.3/1.3	0.22/0.20	16/15	32/28	885
JM-05029A23-3B	220/240	50/60	2150/1850	2.0/1.5	1.3/1.1	0.09/0.09	16/15	30/25	885
JM-05042A12-3B	110/120	50/60	2400/2300	3.4/3.1	1.7/1.7	0.32/0.30	23/22	37/34	1195
JM-05042A23-3B	220/240	50/60	2300/2000	3.1/2.8	1.7/1.5	0.15/0.13	21/20	34/29	1195

GULF ELECTRICS CO., LTD

Latest Product Information: www.gulf.com.tw/en
+886-7-5219966 ; service@gulf.com.tw



JM-060A



General Specifications

Airflow	3.0~6.2 m ³ /min
Static Pressure	1.8~2.6 mmAq
Housing	Aluminum
Blade	ALUMINUM ALLOY
Connecting	Wire Leads

Performance

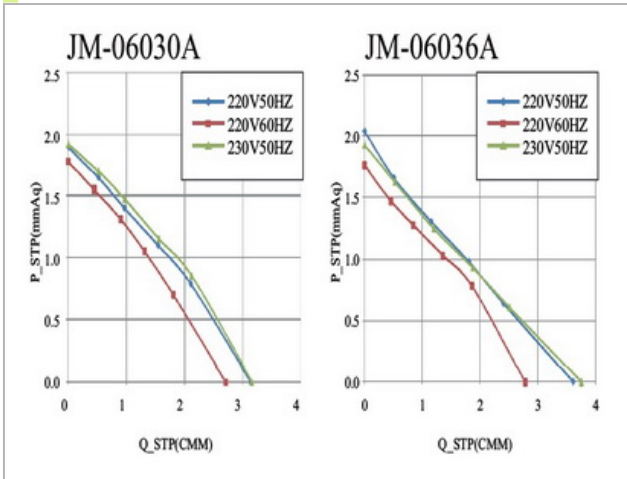

Performance

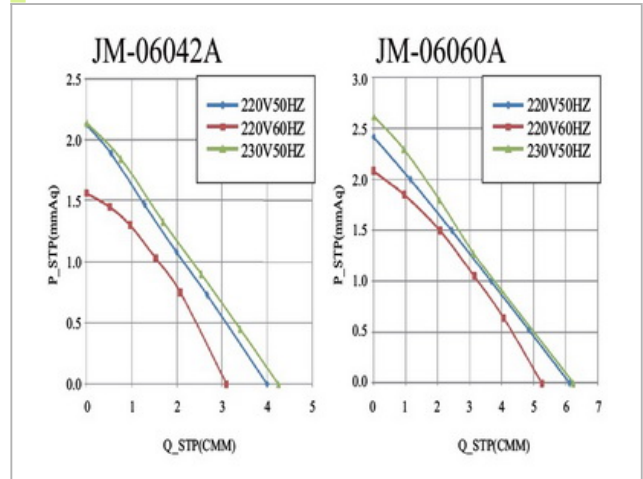

Dimensions:mm

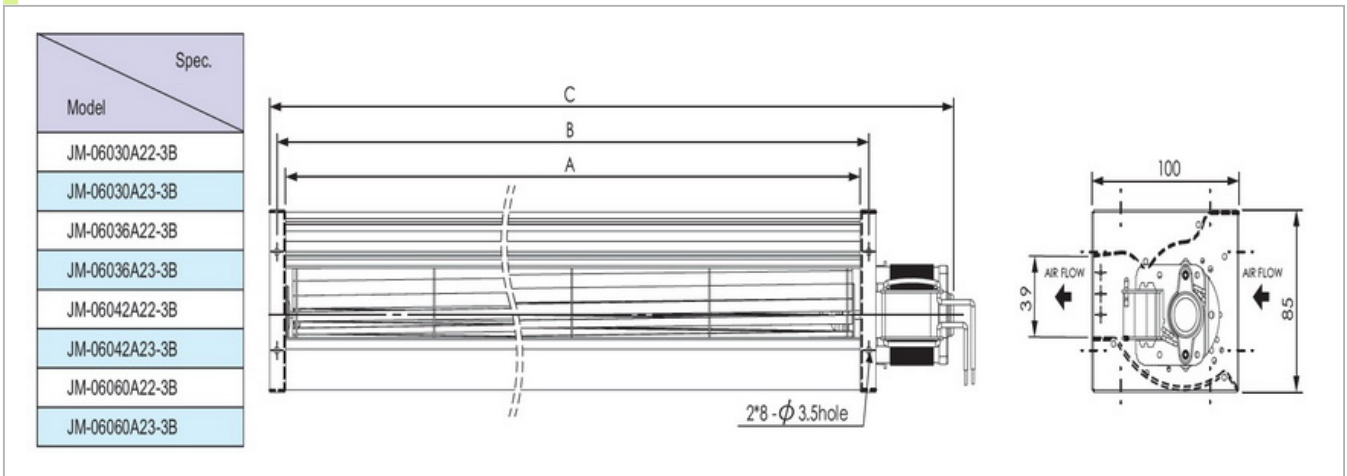

Specifications

Model NO.	Rated Voltage	Frequency	Speed	Airflow	Static Pressure	Current	Power	Noise	Weight
	VAC								
JM-06030A22-3B	220	50/60	2450/2400	3.1/3.0	1.8/1.8	0.19/0.18	24/24	40/38	1.5
JM-06030A23-2B	230	50	2550	3.3	1.8	0.20	26	41	1.5
JM-06036A22-3B	220	50/60	2350/2100	3.6/2.8	2.0/1.8	0.19/0.18	25/25	37/33	1.6
JM-06036A23-3B	230	50	2400	3.8	1.9	0.20	27	38	1.6
JM-06042A22-3B	220	50/60	2250/1800	4.0/3.1	2.1/1.6	0.20/0.19	26/25	39/30	1.7
JM-06042A23-3B	230	50	2300	4.2	2.1	0.21	28	37	1.7
JM-06060A22-3B	220	50/60	2450/2250	6.1/5.3	2.4/2.1	0.39/0.36	46/45	44/36	2.0
JM-06060A23-3B	230	50	2500	6.2	2.6	0.43	51	44	2.0

GULF ELECTRICS CO., LTD

Latest Product Information: www.gulf.com.tw/en
+886-7-5219966 ; service@gulf.com.tw



JEC-060A



General Specifications

Airflow	183~267 CFM
Static Pressure	4.1~7.8 mmAq
Housing	Black Zinc Electroplating
Blade	ALUMINUM ALLOY
Motor Type	AC Induction Capacitor

Performance

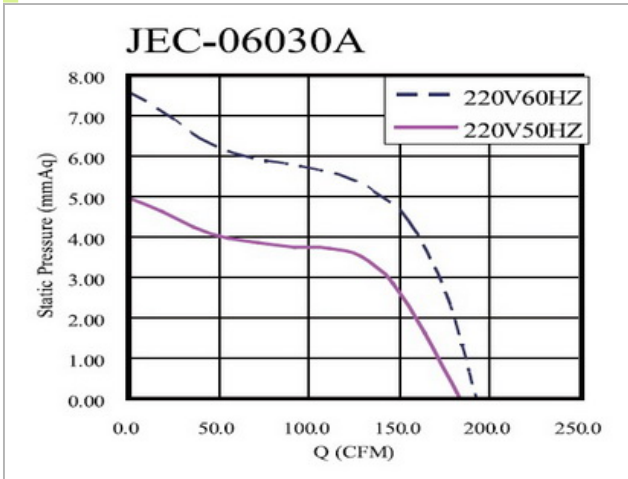

Performance

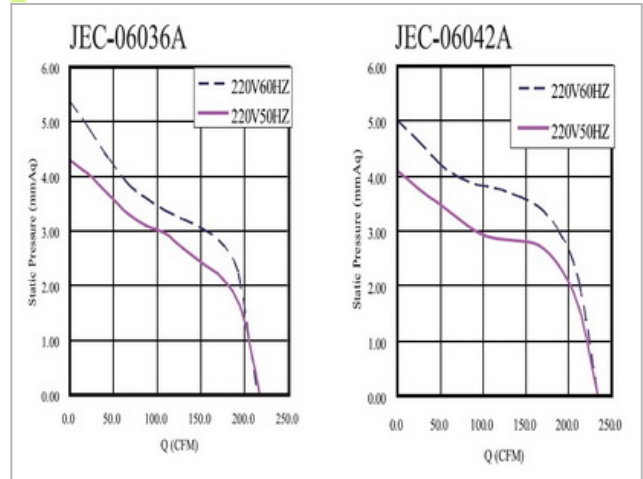

Dimensions:mm

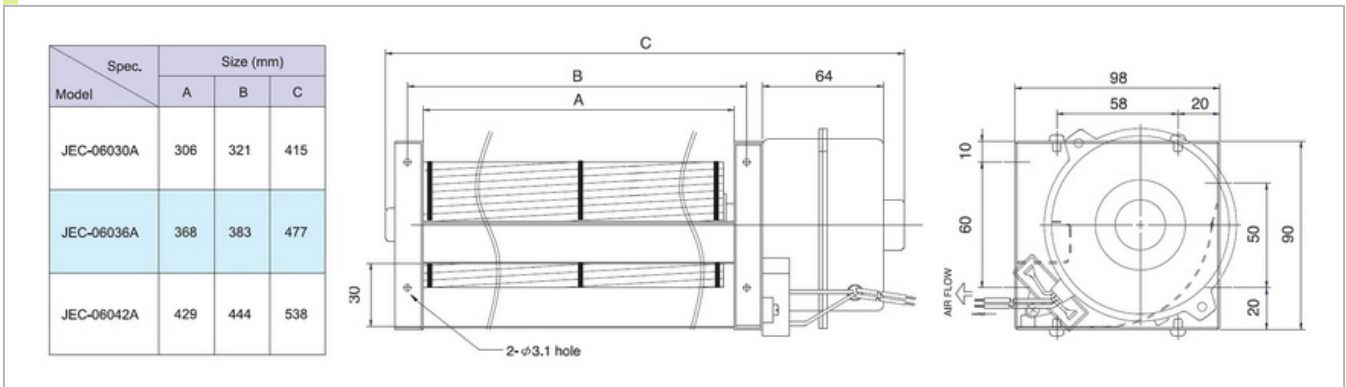

Specifications

Model NO.	Rated Voltage	Frequency	Speed	Airflow	Static Pressure	Current	Power	Noise	Weight
	VAC	HZ	RPM	CFM	mmAq	A	W	dBA	g
JEC-06030A12	110/120	50/60	2800/2900	194/205	7.6/7.8	0.32/0.33	35/39	54/55	1800
JEC-06030A23	220/240	50/60	2600/2800	183/194	5.0/7.6	0.14/0.17	30/38	50/54	1800
JEC-06036A12	110/120	50/60	2500/2600	223/240	5.4/6.7	0.34/0.35	38/42	53/54	1850
JEC-06036A23	220/240	50/60	2500/2500	219/223	4.3/5.4	0.15/0.18	32/40	53/53	1850
JEC-06042A12	110/120	50/60	2400/2600	240/267	4.8/5.9	0.38/0.39	42/47	52/54	1930
JEC-06042A22	220/240	50/60	2400/2500	234/252	6.6/7.1	0.16/0.19	35/43	52/53	1930

GULF ELECTRICS CO., LTD

Latest Product Information: www.gulf.com.tw/en
 +886-7-5219966 ; service@gulf.com.tw



JFC-060A

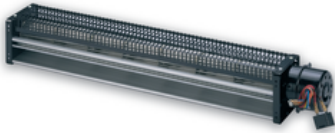

General Specifications

Airflow	177~424 CFM
Static Pressure	1.4~7.2 mmAq
Housing	Black Zinc Electroplating
Blade	ALUMINUM ALLOY
Motor Type	AC Induction Capacitor

Performance

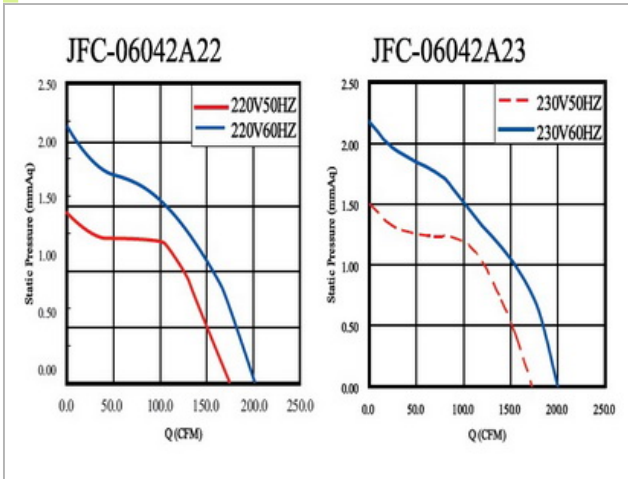

Performance

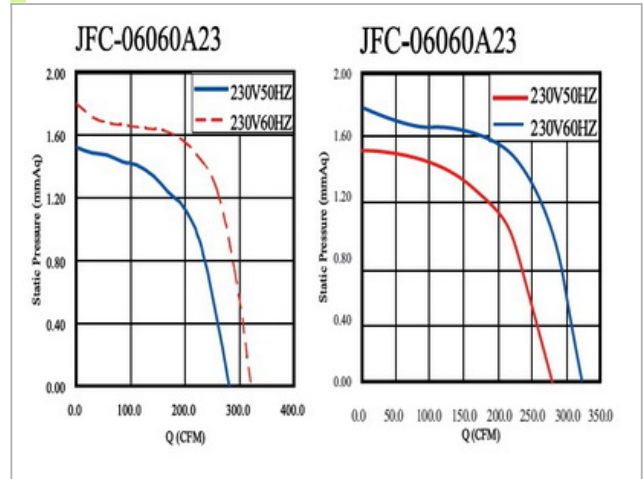

Dimensions:mm

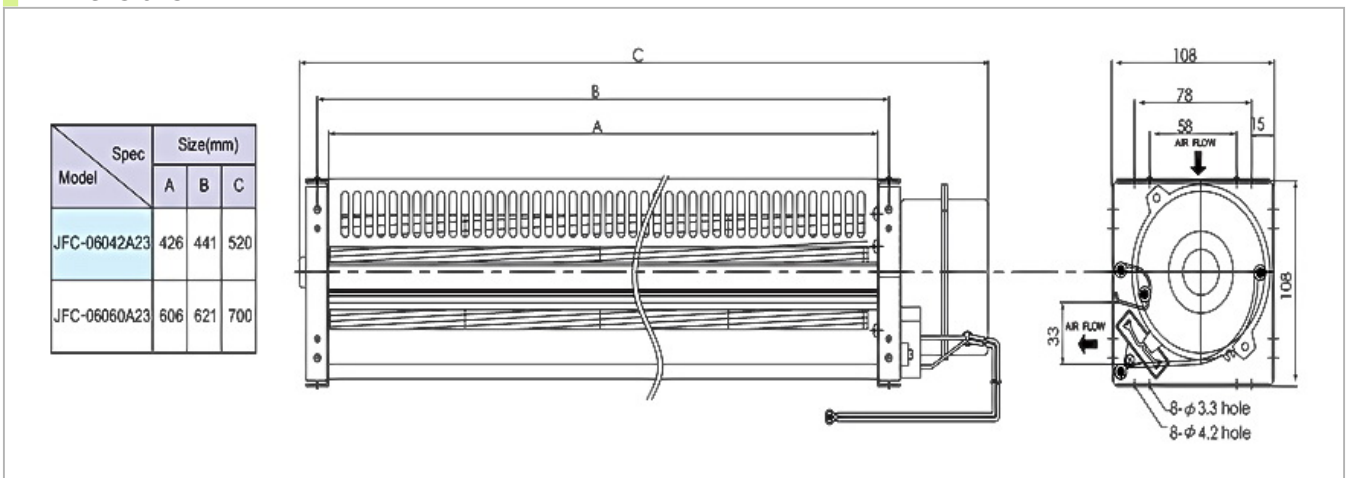

Specifications

Model NO.	Rated Voltage Frequency		Speed	Airflow	Static Pressure	Current	Power	Noise	Weight
	VAC	HZ							
JFC-06042A23	220/240	50/60	1400/1700	177/198	1.4/2.2	0.10/0.16	24/38	34/35	2800
JFC-06060A23	220/240	50/60	1400/1650	283/318	1.5/2.1	0.11/0.17	24/40	37/38	3200
JFC-06060A1122	110/120	50/60	2200/2000	389/354	5/6	0.54/0.67	59/73	53/51	3300
JFC-06060A1122	220/240	50/60	2200/2300	389/424	5/6	0.28/0.34	61/75	53/54	3300

GULF ELECTRICS CO., LTD

Latest Product Information: www.gulf.com.tw/en
+886-7-5219966 ; service@gulf.com.tw



JE-060A



General Specifications

Airflow	63~180 CFM
Static Pressure	2.2~7.3 mmAq
Housing	Black Zinc Electroplating
Blade	ALUMINUM ALLOY
Connecting	Wire Leads

Performance

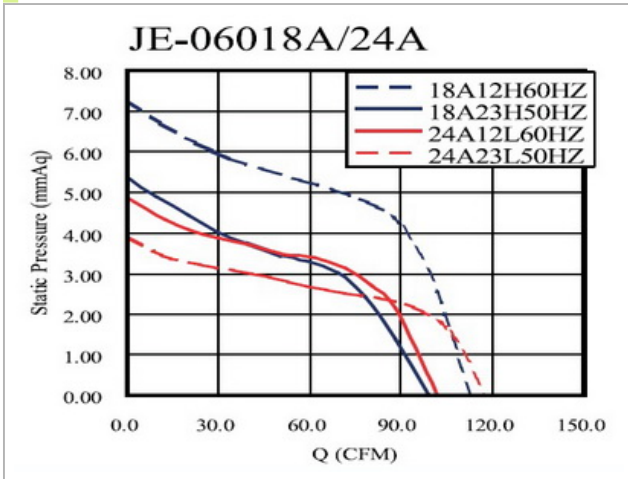

Performance

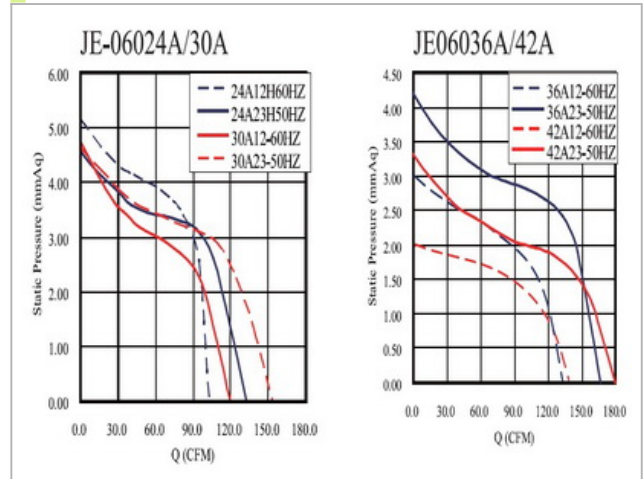

Dimensions:mm

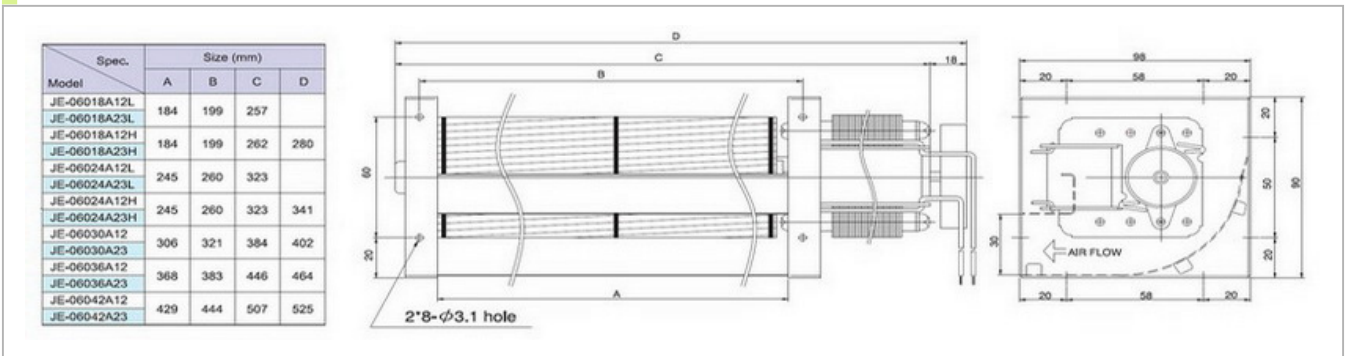

Specifications

Model NO.	Rated Voltage VAC	Frequency HZ	Speed RPM	Airflow CFM	Static Pressure mmAq	Current A	Power W	Noise dBA	Weight g
JE-06018A12L	110/120	50/60	1700	63	3.8	0.33	23	35	1200
JE-06018A23L	220/240	50/60	2000	88	3.7	0.17	23	39	1200
JE-06018A12H	110/120	50/60	2500	106	7.3	0.55	37	47	1350
JE-06018A23H	220/240	50/60	2500	106	5.4	0.27	34	47	1350
JE-06024A12L	110/120	50/60	1900	102	4.9	0.42	31	41	1400
JE-06042A23L	220/240	50/60	2000	118	3.9	0.23	31	42	1400
JE-06024A12H	110/120	50/60	2000	106	5.1	0.60	42	42	1500
JE-06024A23H	220/240	50/60	2200	133	4.6	0.27	35	44	1500
JE-06030A12	110/120	50/60	1900	114	4.7	0.63	42	42	1500
JE-06030A23	220/240	50/60	2200	154	4.6	0.28	36	44	1500
JE-06036A12	110/120	50/60	1700	133	3.0	0.64	43	41	1600
JE-06036A23	220/240	50/60	2000	167	4.2	0.30	38	43	1600
JE-06042A12	110/120	50/60	1600	139	2.2	0.64	44	41	1650
JE-06042A23	220/240	50/60	1800	180	3.3	0.31	40	43	1650

JHC-081A



General Specifications

Airflow	5.8~9.4 m ³ /min
Static Pressure	1.3~1.8 mmAq
Housing	ALUMINUM ALLOY
Blade	ALUMINUM ALLOY
Motor Type	AC Induction Capacitor

Performance

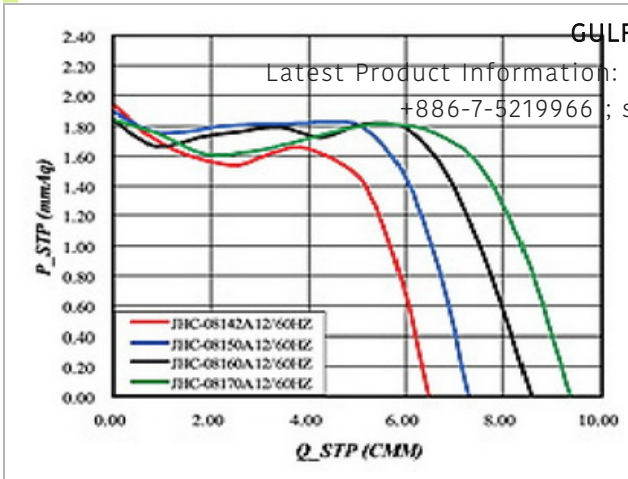

Performance

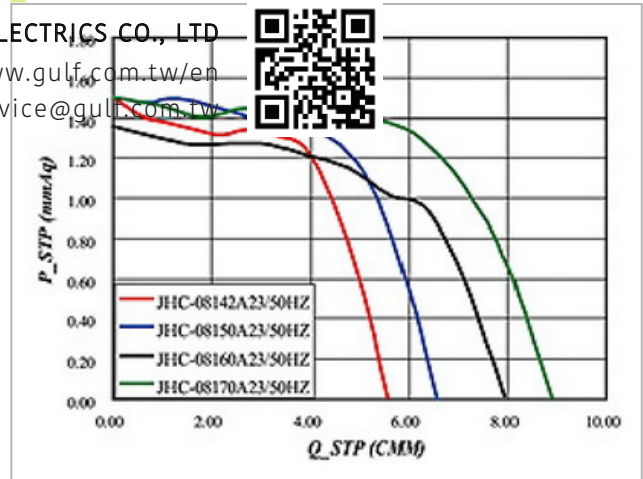

Dimensions:mm

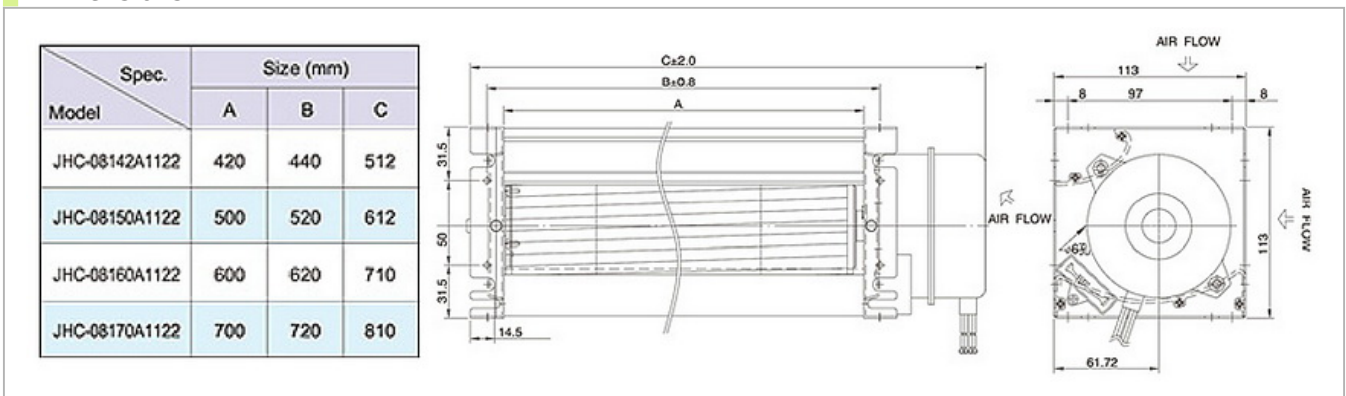

Specifications

Model NO.	Rated Voltage Frequency		Speed	Airflow	Static Pressure	Current	Power	Noise	Weight
	VAC	HZ							
JHC-08142A1122	120/230	50/60	1300/1400	5.8/6.1	1.5/1.8	0.25/0.13	24/29	43/44	2.3
JHC-08150A1122	120/230	50/60	1250/1300	6.3/6.8	1.5/1.8	0.25/0.13	24/30	42/43	2.4
JHC-08160A1122	120/230	50/60	1300/1400	7.9/8.3	1.3/1.8	0.27/0.13	24/32	42/44	3.0
JHC-08170A1122	120/230	50/60	1200/1300	9.4/8.6	1.5/1.8	0.27/0.12	25/33	41/43	3.2

GULF ELECTRICS CO., LTD

Latest Product Information: www.gulf.com.tw/en
+886-7-5219966 ; service@gulf.com.tw



JFC-090B



General Specifications

Airflow	191~743 CFM
Static Pressure	2.5~5.0 mmAq
Housing	Black Zinc Electroplating
Blade	ALUMINUM ALLOY
Motor Type	AC Induction Capacitor

Performance

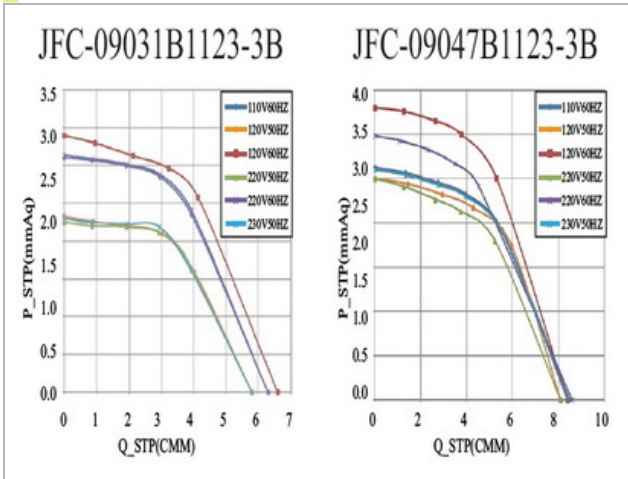

Performance

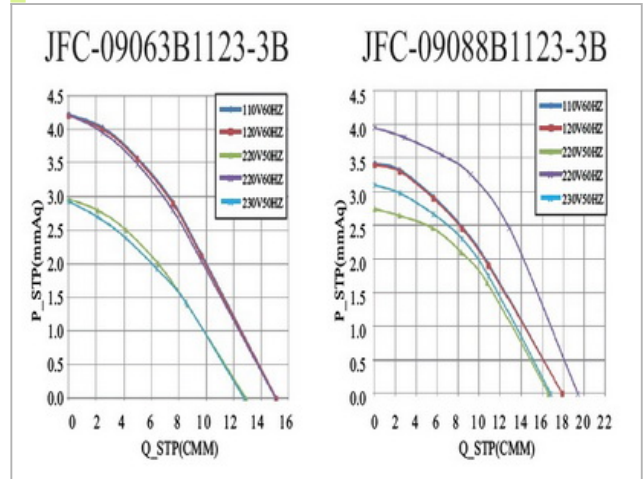

Dimensions:mm

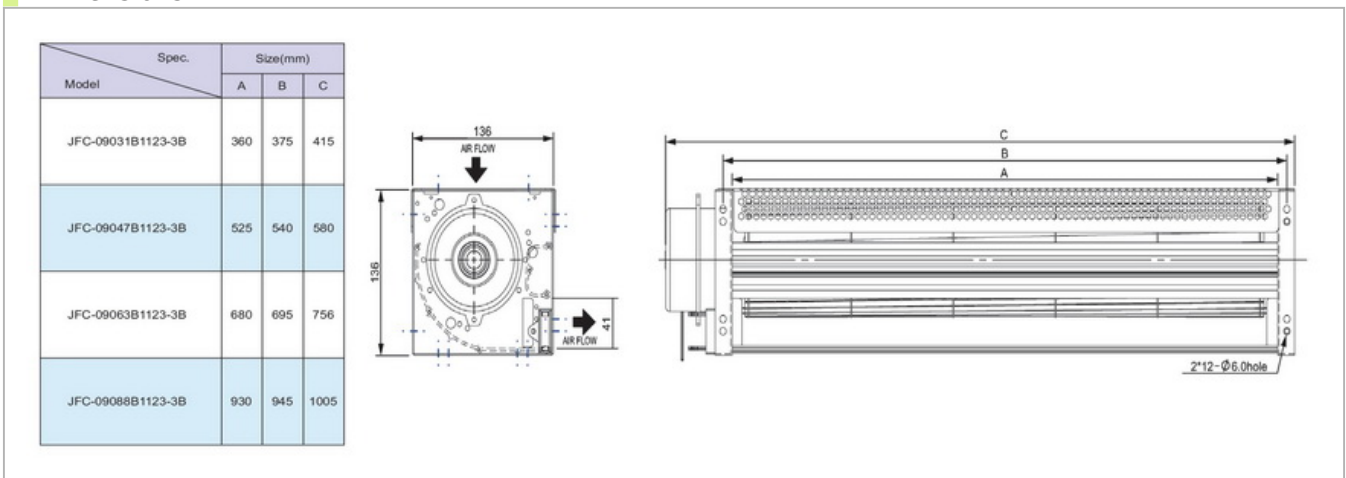

Specifications

Model NO.	Rated Voltage VAC	Frequency HZ	Speed RPM	Airflow M3/MIN	Static Pressure mmAq	Current A	Power W	Noise dBA	Weight KG
JFC-09031B1123-3B	110/120	50/60	1350/1550	5.8/6.6	2.3/3.4	0.29/0.32	32/37	47/53	2.5
JFC-09031B1123-3B	220/240	50/60	1350/1500	5.8/6.6	2.3/3.1	0.15/0.16	29/33	47/49	2.5
JFC-09047B1123-3B	110/120	50/60	1200/1250	8.1/8.4	2.5/3.3	0.32/0.36	35/42	46/47	2.9
JFC-09047B1123-3B	220/240	50/60	1200/1300	8.1/8.6	2.5/3.0	0.16/0.18	32/37	46/48	2.9
JFC-09063B1123	110/120	50/60	1700	15.1/15.1	5.0	0.68/0.70	71/78	54	4.4
JFC-09063B1123	220/240	50/60	1400/1700	13.0/15.1	3.5/5.0	0.38/0.40	59/74	49/54	4.4
JFC-09088B1123	110/120	50/60	1600	17.9/17.9	4.5	0.80/0.82	85/93	56	4.7
JFC-09088B1123	220/240	50/60	1400/1700	16.6/19.4	3.0/4.0	0.41/0.43	69/88	52/57	4.7

GULF ELECTRICS CO., LTD

Latest Product Information: www.gulf.com.tw/en
+886-7-5219966 ; service@gulf.com.tw



JFC-110B



General Specifications

Airflow	12~33 m3/min
Static Pressure	5.0~9.5 mmAq
Housing	Black Zinc Electroplating
Blade	ALUMINUM ALLOY
Motor Type	AC Induction Capacitor

Performance

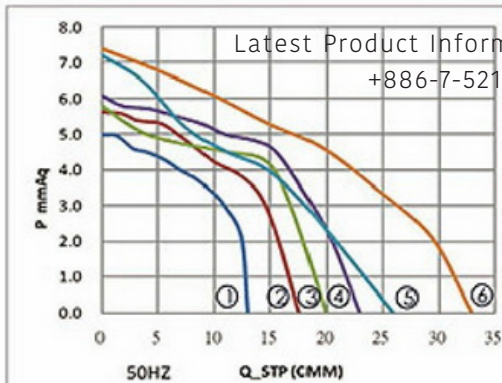

Performance

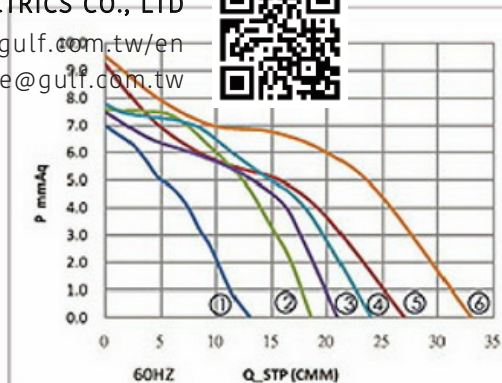

GULF ELECTRICS CO., LTD

Latest Product Information: www.gulf.com.tw/en

+886-7-5219966 ; service@gulf.com.tw



Model	Spec.	Size (mm)		
		A	B	C
JFC-11037B22 ①		385	405	498
JFC-11048B22 ②		495	515	608
JFC-11052B22 ③		535	555	648
JFC-11060B22 ④		625	645	755
JFC-11067B22 ⑤		685	705	798
JFC-11088B22 ⑥		897	917	1010

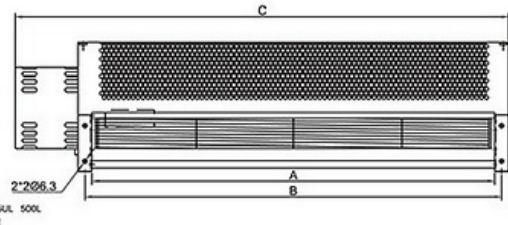
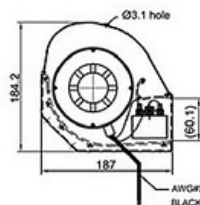

Specifications

Model NO.	Rated Voltage VAC	Frequency HZ	Speed RPM	Airflow M3/MIN	Static Pressure mmAq	Current A	Power W	P-Q Curve	Noise dBA	Weight KG
JFC-11037B22	220/240	50/60	1100/1200	12/13	5.0/7.0	0.27/0.30	60/70	1	52/54	5.0
JFC-11048B22	220/240	50/60	1200/1300	17/18	5.6/7.5	0.40/0.50	90/105	2	56/58	5.5
JFC-11052B22	220/240	50/60	1200/1300	20/21	5.4/7.5	0.40/0.50	90/110	3	56/58	6.0
JFC-11060B22	220/240	50/60	1250/1300	23/24	6.1/7.8	0.45/0.57	105/130	4	57/58	6.4
JFC-11067B22	220/240	50/60	1200/1300	26/27	7.2/9.2	0.50/0.60	102/126	5	56/58	6.7
JFC-11088B22	220/240	50/60	1200/1200	33/33	7.4/9.5	0.60/0.80	136/175	6	58/58	8.1

GULF ELECTRICS CO., LTD

Latest Product Information: www.gulf.com.tw/en

+886-7-5219966 ; service@gulf.com.tw



JEC-150A

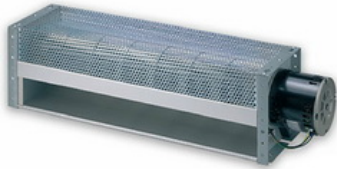

General Specifications

Airflow	1168~1770 CFM
Static Pressure	5.0~7.2 mmAq
Housing	ALUMINUM ALLOY
Blade	ALUMINUM ALLOY
Motor Type	AC Induction Capacitor

Performance

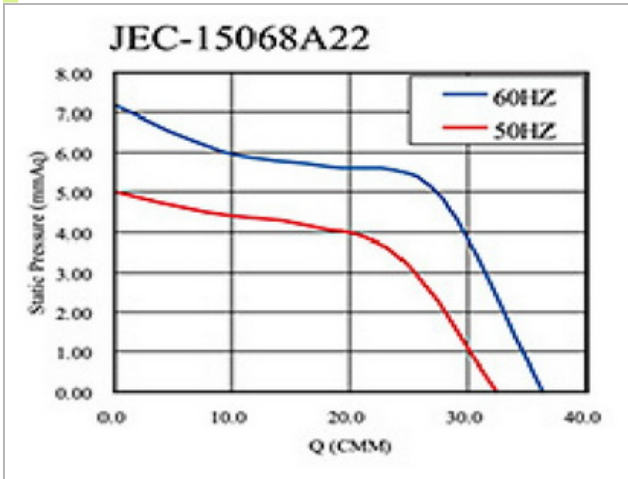

Performance

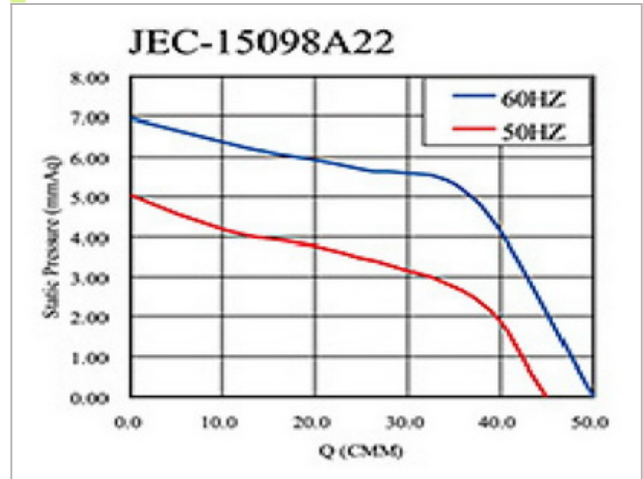

Dimensions:mm

Spec.	Size (mm)		
	A	B	C
JEC-15068A	700	730	866
JEC-15098A	1000	1030	1166

Specifications

Model NO.	Rated Voltage VAC	Frequency HZ	Speed RPM	Airflow CFM	Static Pressure mmAq	Current A	Power W	Noise dBA	Weight KG
JEC-15068A	220/240	50/60	950/1150	1168/1274	5.0/7.2	1.2/1.1	156/210	59/63	13.6
JEC-15098A	220/240	50/60	900/1100	1593/1770	5.0/6.9	1.3/1.3	190/265	59/63	15.8

GULF ELECTRICS CO., LTD

Latest Product Information: www.gulf.com.tw/en
+886-7-5219966 ; service@gulf.com.tw



DC Cross Flow Fans



JED-025A

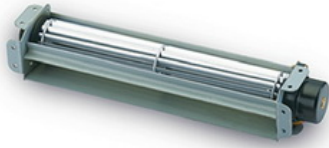

General Specifications

Airflow	11~30 CFM
Static Pressure	1.3~1.8 mmAq
Housing	Steel
Blade	ALUMINUM ALLOY
Connecting	Wire Leads

Performance

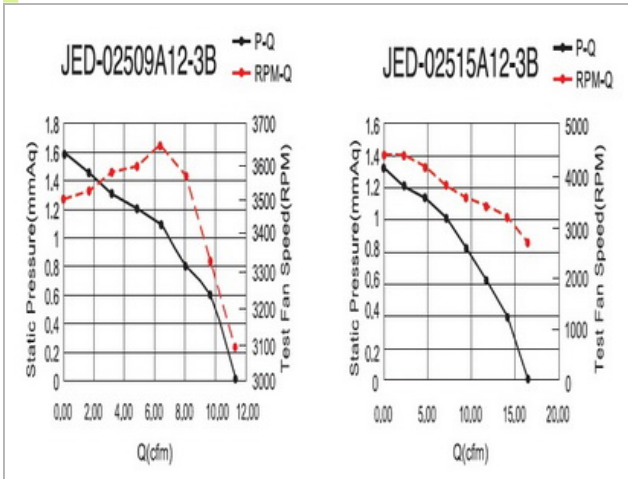

Performance

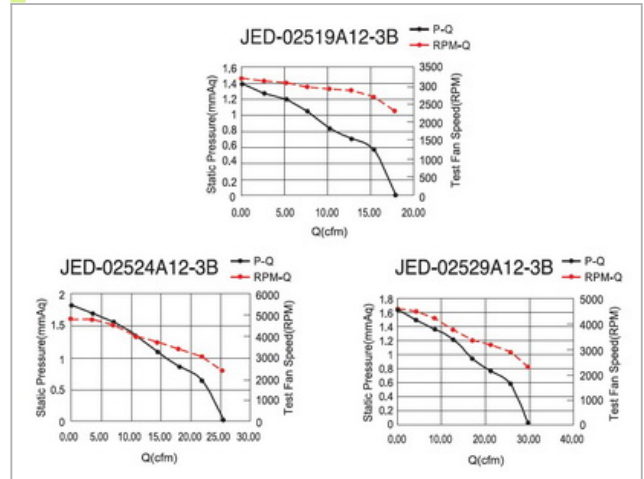

Dimensions:mm

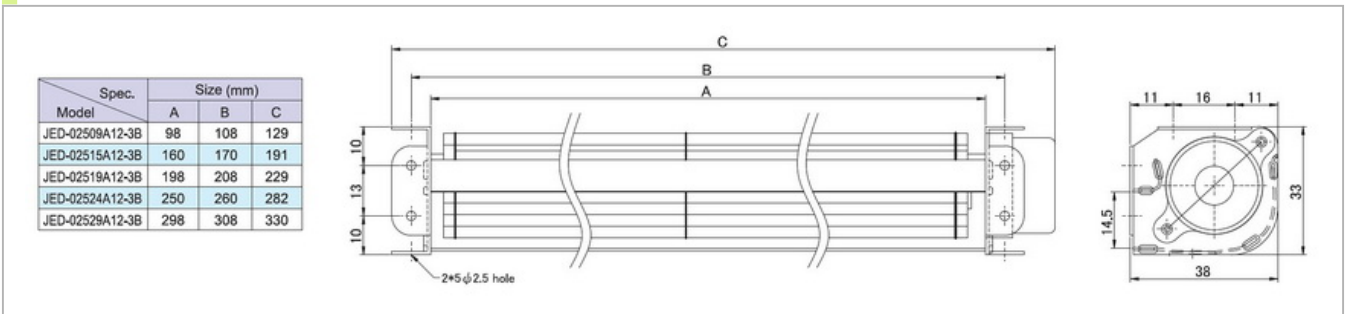

Specifications

Model NO.	Rated Voltage	Speed/Airflow		Static Pressure	Current/Noise/Weight		
	VDC	RPM	CFM		A	dBA	g
JED-02509A12-3B	12	3100	11	1.6	0.11	32	95
JED-02515A12-3B	12	2700	16	1.4	0.13	29	120
JED-02519A12-3B	12	2500	18	1.3	0.14	28	140
JED-02524A12-3B	12	2600	25	1.8	0.20	32	160
JED-02529A12-3B	12	2500	30	1.6	0.21	33	180

GULF ELECTRICS CO., LTD

Latest Product Information: www.gulf.com.tw/en
+886-7-5219966 ; service@gulf.com.tw



JVD-025A



General Specifications

Airflow	9~15 CFM
Static Pressure	1.0~1.8 mmAq
Housing	Steel
Blade	ALUMINUM ALLOY
Connecting	Wire Leads

Performance

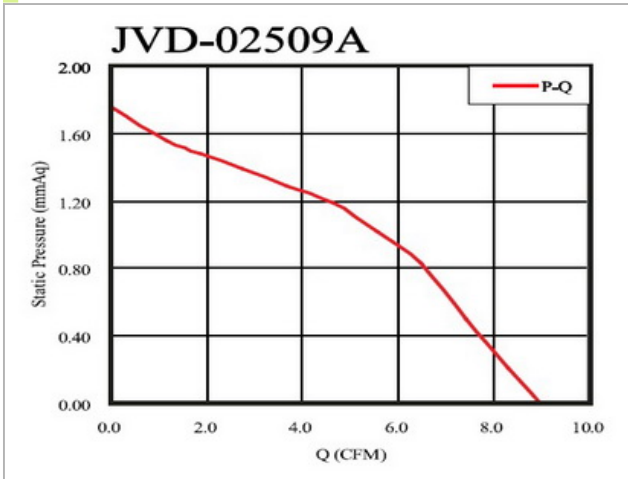

Performance

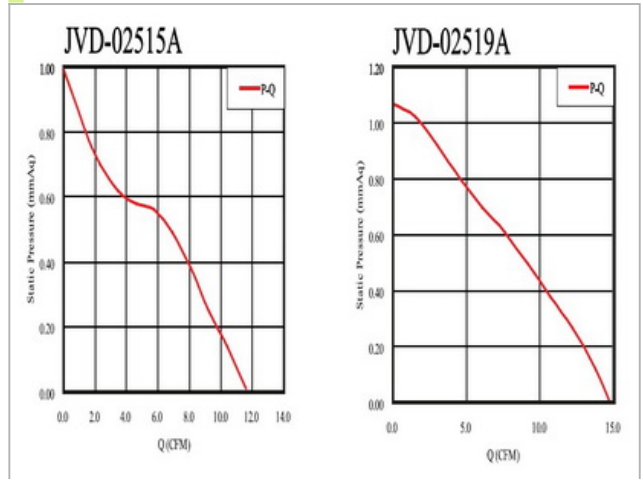

Dimensions:mm

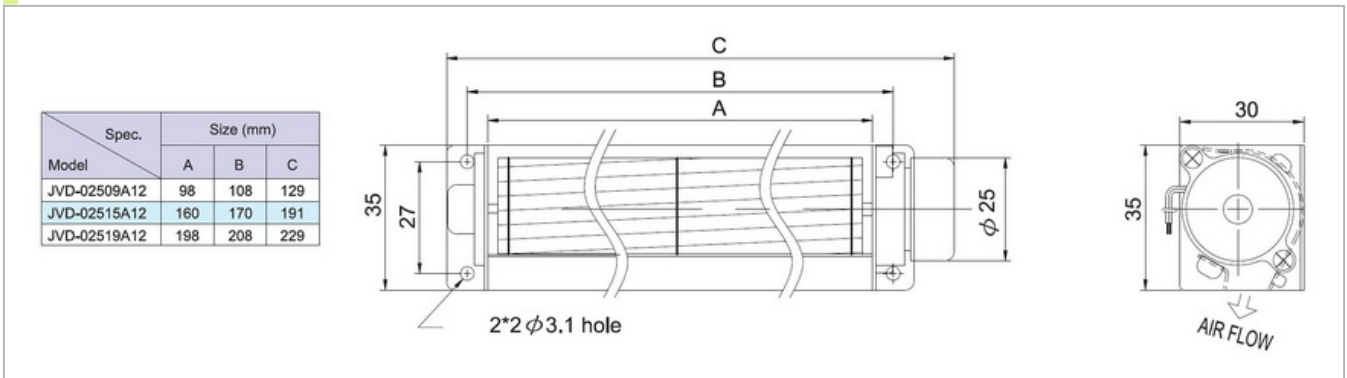

Specifications

Model NO.	Rated Voltage	Speed/Airflow		Static Pressure	Current/Noise/Weight		
	VDC	RPM	CFM	mmAq	A	dBA	g
JVD-02509A12	12	4000	9	1.8	0.13	30	80
JVD-02515A12	12	3400	12	1.0	0.13	31	100
JVD-02519A12	12	3300	15	1.0	0.13	35	110

GULF ELECTRICS CO., LTD

Latest Product Information: www.gulf.com.tw/en

+886-7-5219966 ; service@gulf.com.tw



JSD-030A



General Specifications

Airflow	29~33 CFM
Static Pressure	1.5~1.9 mmAq
Housing	Steel
Blade	ALUMINUM ALLOY
Connecting	Wire Leads

Performance

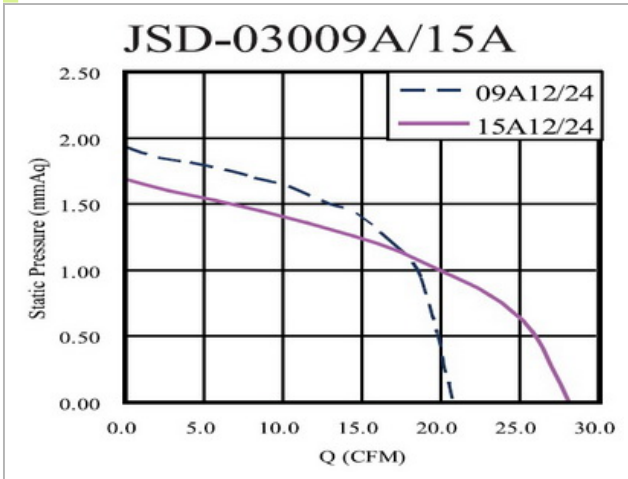

Performance

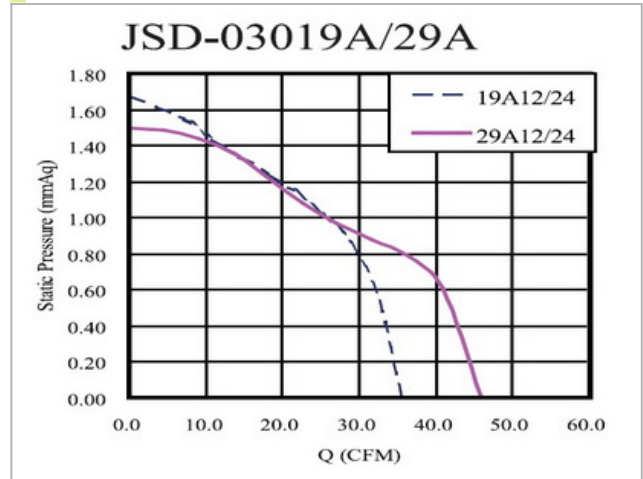

Dimensions:mm

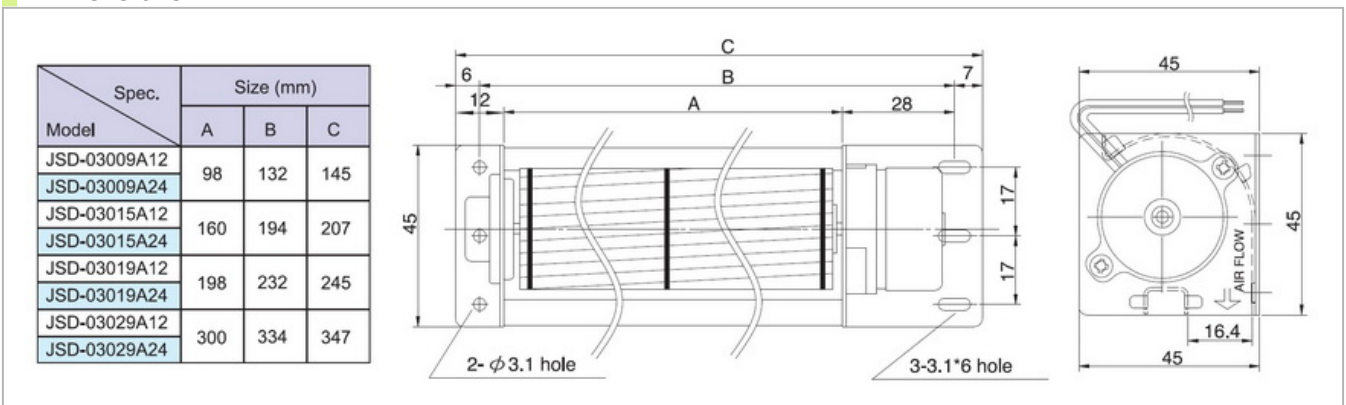

Specifications

Model NO.	Rated Voltage	Speed/Airflow		Static Pressure	Current/Noise/Weight		
	VDC	RPM	CFM		A	dBA	g
JSD-03009A12	12	3200	21	1.9	0.15	29	160
JSD-03009A24	24	3200	21	1.9	0.15	29	160
JSD-03015A12	12	3100	28	1.7	0.18	30	190
JSD-03015A24	24	3100	28	1.7	0.16	30	190
JSD-03019A12	12	2900	35	1.6	0.20	31	210
JSD-03019A24	24	2900	35	1.6	0.16	31	210
JSD-03029A12	12	2600	49	1.5	0.22	33	290
JSD-03029A24	24	2600	49	1.5	0.20	33	290

GULF ELECTRICS CO., LTD

Latest Product Information: www.gulf.com.tw/en
+886-7-5219966 ; service@gulf.com.tw



JED/JF3-030A



General Specifications

Airflow	22~53 CFM
Static Pressure	1.5~1.9 mmAq
Housing	Black Zinc Electroplating
Blade	ALUMINUM ALLOY
Connecting	Wire Leads

Performance

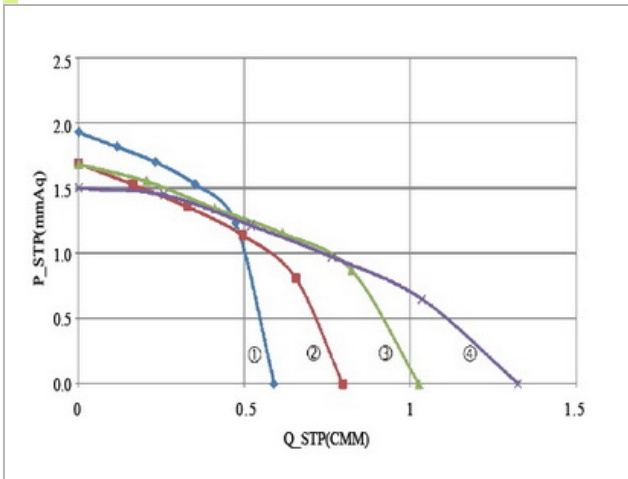

Performance

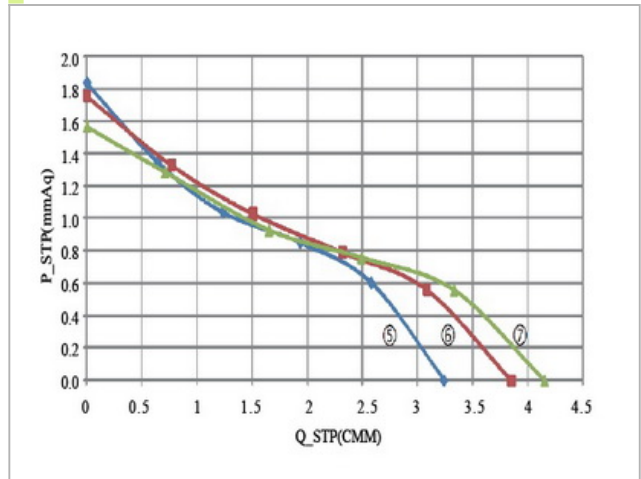

Dimensions:mm

Model	Spec.	Size(mm)			
		A	B	C	D
JED-03009A12-3B	①	98	108	134	31
JED-03009A24-3B	①	98	108	134	31
JED-03015A12-3B	②	160	170	196	31
JED-03015A24-3B	②	160	170	196	31
JED-03019A12-3B	③	198	208	234	31
JED-03019A24-3B	③	198	208	234	31
JED-03029A12-3B	④	300	310	336	31
JED-03029A24-3B	④	300	310	336	31
JF3-3030X2A24Q-4B	⑤	630	640	680	38
JF3-3035X2A24Q-4B	⑥	730	740	780	38
JF3-3040X2A24Q-4B	⑦	830	840	880	38

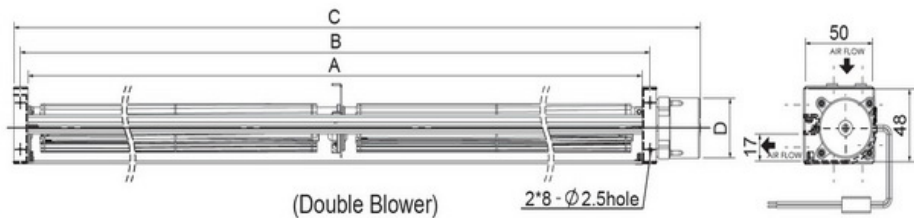

Specifications

Model NO.	Rated Voltage	Speed Airflow		Static Pressure	CurrentNoiseWeight		
	VDC	RPM	CFM		A	dBA	g
JED-03009A12	12	3200	22	1.9	0.15	29	180
JED-03009A24	24	3200	22	1.9	0.18	29	180
JED-03015A12	12	3100	28	1.7	0.16	30	210
JED-03015A24	24	3100	28	1.7	0.15	30	210
JED-03019A12	12	2900	35	1.7	0.20	31	230
JED-03019A24	24	2900	35	1.7	0.16	31	230
JED-03029A12	12	2600	46	1.5	0.22	33	290
JED-03029A24	24	2600	46	1.5	0.20	33	290
JF3-3030X2A24Q-4B	24	2850	112.32	1.8	0.22	36	580
JF3-3035X2A24Q-4B	24	2750	136.90	1.7	0.25	35	630
JF3-3040X2A24Q-3B	24	2650	147.42	1.6	0.28	34	690

GULF ELECTRICS CO., LTD

Latest Product Information: www.gulf.com.tw/en
+886-7-5219966 ; service@gulf.com.tw



JED/JE3/JF3-040A



General Specifications

Airflow	0.7~4.6 m3/min
Static Pressure	2.0~2.9 mmAq
Housing	Black Zinc Electroplating
Blade	ALUMINUM ALLOY
Connecting	Wire Leads

Performance

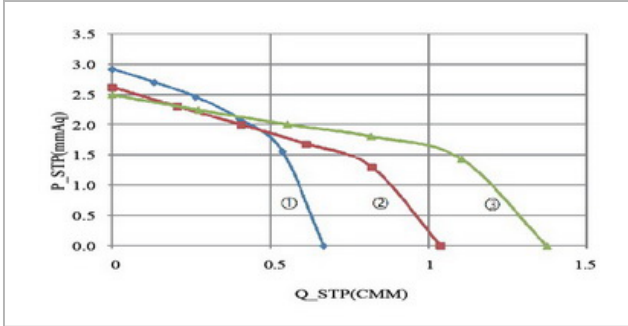

Performance

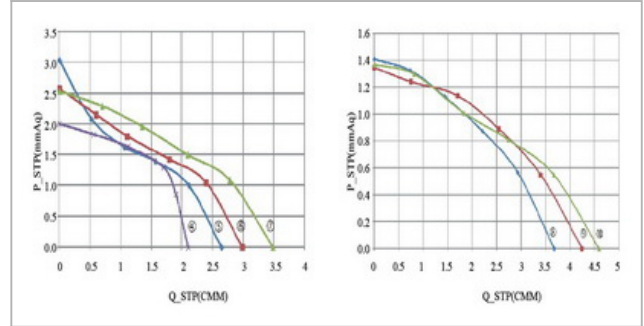

Dimensions:mm

Model	Spec	Size(mm)			
		A	B	C	D
JED-04009A12-3B	①	98	108	144	31
JED-04009A24-3B	①	98	108	144	31
JED-04015A12-3B	②	160	170	206	31
JED-04015A24-3B	②	160	170	206	31
JED-04019A12Q-3B	③	198	208	246	38
JED-04019A24Q-3B	③	198	208	246	38
JED-04029A12Q-3B	④	300	310	348	38
JED-04029A24Q-3B	④	300	310	348	38
JE3-04030A24-3B	⑤	310	320	350	38
JE3-04035A24-3B	⑥	360	370	400	38
JE3-04040A24-3B	⑦	410	420	450	38
JF3-4030X2A24-3B	⑧	630	640	660	38
JF3-4035X2A24-3B	⑨	730	740	760	38
JF3-4040X2A24-3B	⑩	830	840	860	38

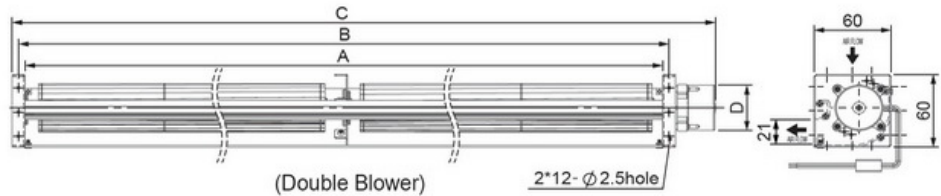

Specifications

Model NO.	Rated Voltage		Speed Airflow		Static Pressure	Current Noise Weight		
	VDC		RPM	M3/MIN		A	dBA	g
JED-04009A12Q	12		3000	0.7	2.9	0.20	33	220
JED-04009A24Q	24		3000	0.7	2.9	0.15	33	220
JED-04015A12Q	12		2600	1.0	2.6	0.25	31	260
JED-04015A24Q	24		2600	1.0	2.6	0.25	31	260
JED-04019A12Q	12		2500	1.4	2.5	0.30	33	310
JED-04019A24Q	24		2500	1.4	2.5	0.20	33	310
JED-04029A12Q	12		2300	2.1	2.0	0.40	33	410
JED-04029A24Q	24		2300	2.1	2.0	0.20	33	410
JE3-04030A24-3B	24		2600	2.6	3.0	0.30	39	440
JE3-04035A23-3B	24		2450	3.0	2.6	0.32	38	470
JF3-04040A24-3B	24		2300	3.5	2.5	0.34	37	510
JF3-4030X2A24-3B	24		1800	3.7	1.4	0.26	39	690
JF3-4035X2A24-3B	24		1750	4.2	1.4	0.27	38	770
JF3-4040X2A24-3B	24		1600	4.6	1.3	0.28	37	830

GULF ELECTRICS CO., LTD

Latest Product Information: www.gulf.com.tw/en

+886-7-5219966 ; service@gulf.com.tw



JQ3-043A



General Specifications

Airflow	2.0~2.2 m3/min
Static Pressure	1.1~1.2 mmAq
Housing	Zinc
Blade	ALUMINUM ALLOY
Connecting	Wire Leads

Performance

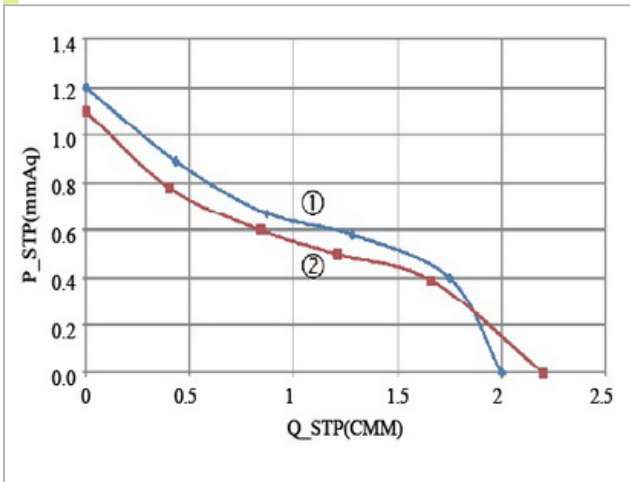

Model	Spec.	Size(mm)		
		A	B	C
JQ3-04325A24-3B	①	250	260	297
JQ3-04329A24-3B	②	290	300	337

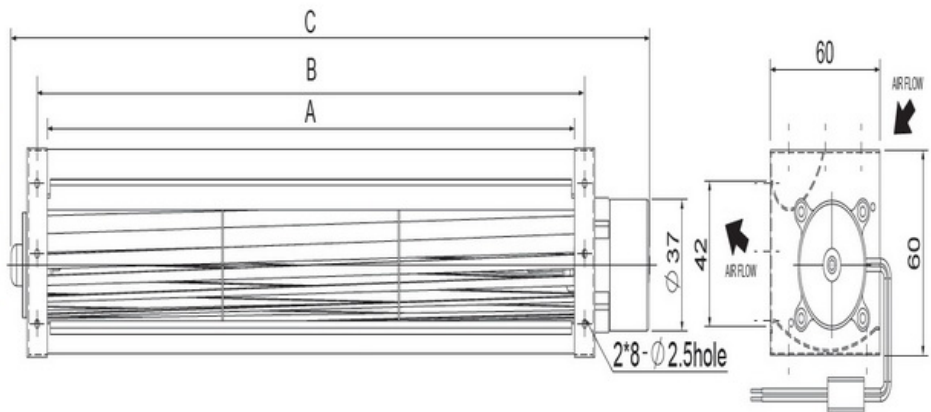

Specifications

Model NO.	Rated Voltage	Speed Airflow		Static Pressure	Current Noise Weight		
	VDC	RPM	M3/MIN		A	dBA	g
JQ3-04325A24-3B	24	2500	2.0	1.2	0.26	36	340
JQ3-04329A24-3B	24	2700	2.2	1.1	0.25	38	370



JED/JE3-043A



General Specifications

Airflow	0.7~2.8 m3/min
Static Pressure	0.7~1.9 mmAq
Housing	Black Zinc Electroplating
Blade	ALUMINUM ALLOY
Connecting	Wire Leads

Performace

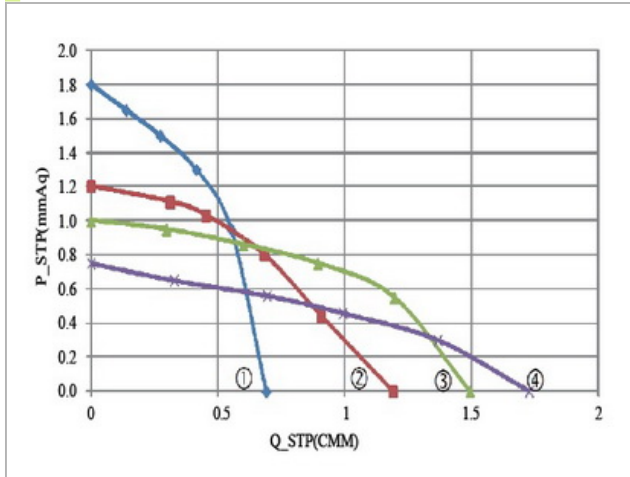

Performace

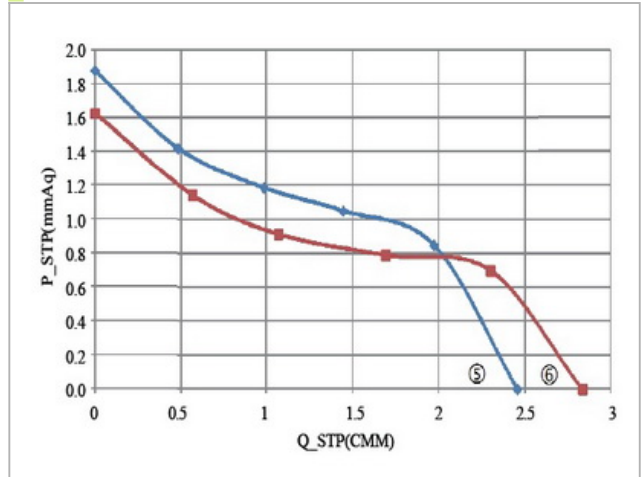

Dimensions:mm

Model	Spec.	Size(mm)			
		A	B	C	D
JED-04309A12-3B	①	98	108	144	31
JED-04309A24-3B	①	98	108	144	31
JED-04315A12Q-3B	②	160	170	208	38
JED-04315A24Q-3B	②	160	170	208	38
JED-04319A12Q-3B	③	198	208	246	38
JED-04319A24Q-3B	③	198	208	246	38
JED-04324A12Q-3B	④	250	260	298	38
JED-04324A24Q-3B	④	250	260	298	38
JE3-04329A24-3B	⑤	300	310	340	38
JE3-04335A24-3B	⑥	360	370	400	38

Specifications

Model NO.	Rated Voltage VDC	Speed Airflow		Static Pressure mmAq	Current Noise Weight		
		RPM	M3/MIN		A	dBA	g
JED-04309A12-3B	12	2800	0.7	1.8	0.22	36	220
JED-04309A24-3B	24	2800	0.7	1.8	0.18	36	220
JED-04315A12Q-3B	12	2500	1.2	1.2	0.35	37	270
JED-04315A24Q-3B	24	2500	1.2	1.2	0.20	37	270
JED-04319A12Q-3B	12	2400	1.5	1.0	0.35	39	310
JED-04319A24Q-3B	24	2400	1.5	1.0	0.20	39	310
JED-04324A12Q-3B	12	2200	1.7	0.7	0.42	34	350
JED-04324A24Q-3B	24	2200	1.7	0.7	0.22	34	350
JE3-04329A24-3B	24	2500	2.5	1.9	0.33	37	420
JE3-04335A24-3B	24	2400	2.8	1.6	0.35	37	440

GULF ELECTRICS CO., LTD

Latest Product Information: www.gulf.com.tw/en
+886-7-5219966 ; service@gulf.com.tw



JQ3-045A



General Specifications

Airflow	1.9~3.6 m3/min
Static Pressure	2.6~4.1 mmAq
Housing	Zinc
Blade	ALUMINUM ALLOY
Connecting	Wire Leads

Performance

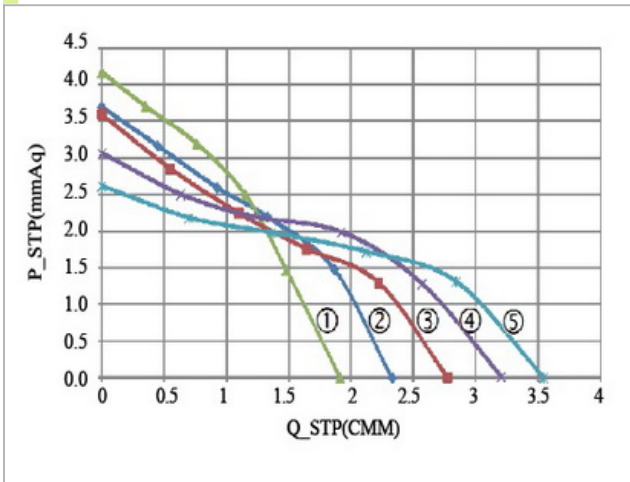

Dimensions:mm

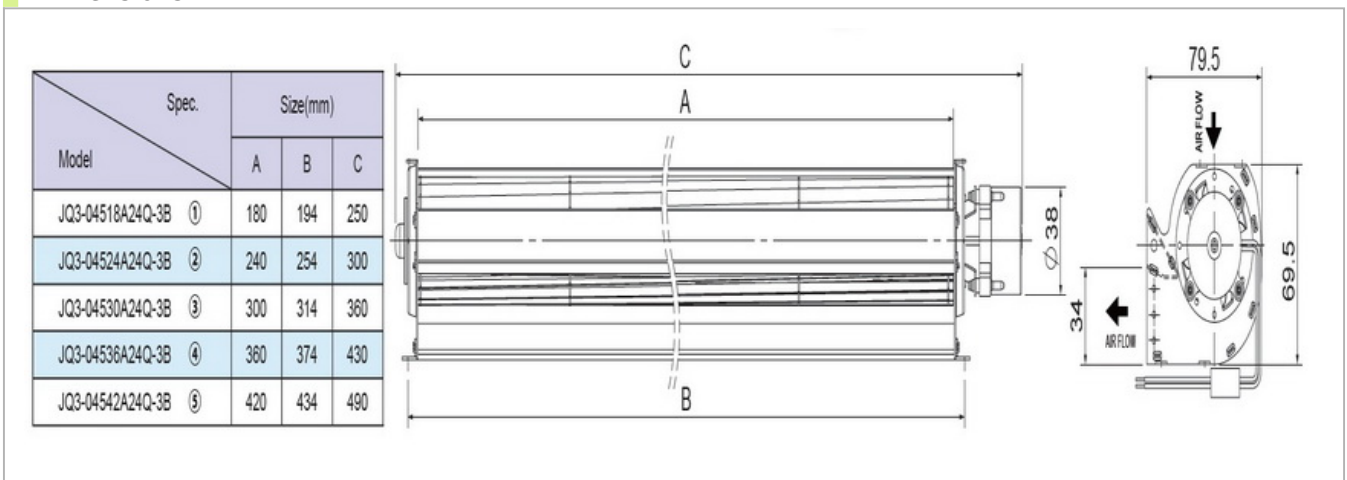

Specifications

Model NO.	Rated Voltage VDC	Speed Airflow		Static Pressure mmAq	Current Noise Weight		
		RPM	M3/MIN		A	dBA	g
JQ3-04518A24Q-3B	24	2000	1.9	4.1	0.23	46	450
JQ3-04524A24Q-3B	24	1800	2.3	3.7	0.24	45	530
JQ3-04530A24Q-3B	24	1700	2.7	3.6	0.27	44	610
JQ3-04536A24Q-3B	24	1600	3.2	3.1	0.29	43	690
JQ3-04542A24Q-3B	24	1500	3.6	2.6	0.30	42	770

GULF ELECTRICS CO., LTD

Latest Product Information: www.gulf.com.tw/en

+886-7-5219966 ; service@gulf.com.tw



JF3-045A



General Specifications



Airflow	5.7~7.5 m3/min
Static Pressure	2.8~2.9 mmAq
Housing	ALUMINUM ALLOY
Blade	ALUMINUM ALLOY
Connecting	Wire Leads

Performance

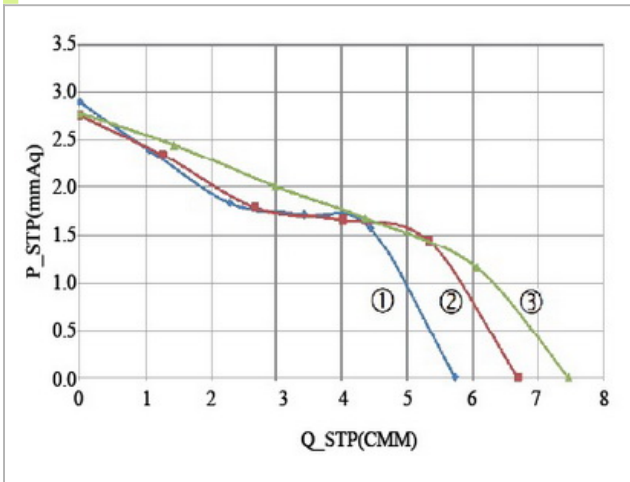

Dimensions:mm

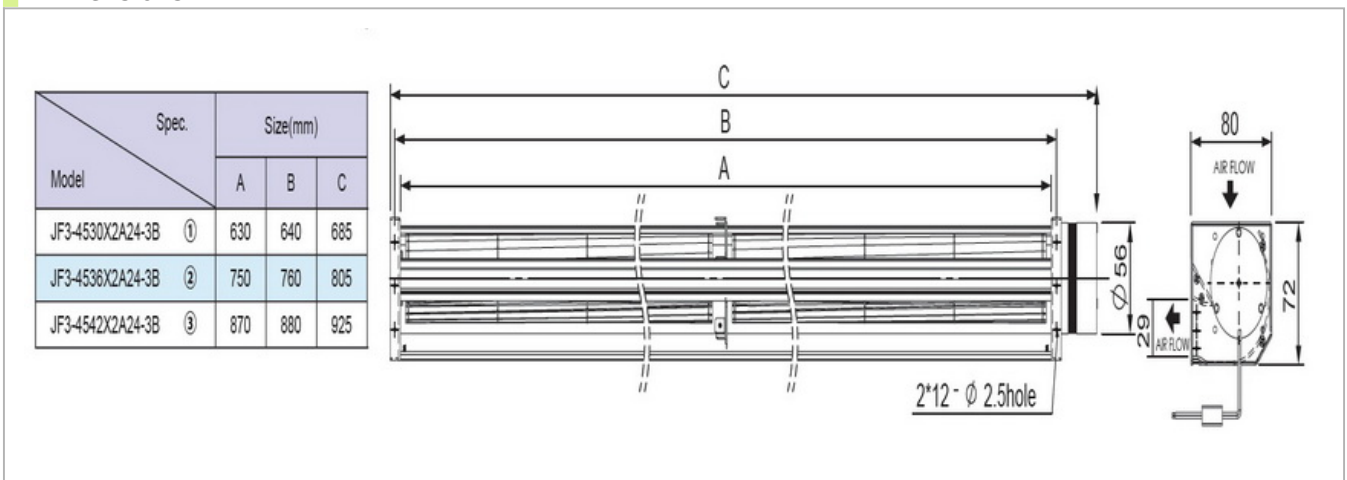

Specifications

Model NO.	Rated Voltage	Speed Airflow		Static Pressure	Current Noise Weight		
	VDC	RPM	M3/MIN	mmAq	A	dBA	KG
JF3-4530X2A24-3B	24	1950	5.7	2.9	0.55	46	1.10
JF3-4536X2A24-3B	24	1850	6.7	2.8	0.59	45	1.25
JF3-4542X2A24-3B	24	1800	7.5	2.8	0.63	45	1.35

GULF ELECTRICS CO., LTD

Latest Product Information: www.gulf.com.tw/en

+886-7-5219966 ; service@gulf.com.tw



JE3/JF3-050A



General Specifications

Airflow	1.3~7.4 m ³ /min
Static Pressure	1.9~5.9 mmAq
Housing	Black Zinc Electroplating
Blade	ALUMINUM ALLOY
Connecting	Wire Leads

Performance

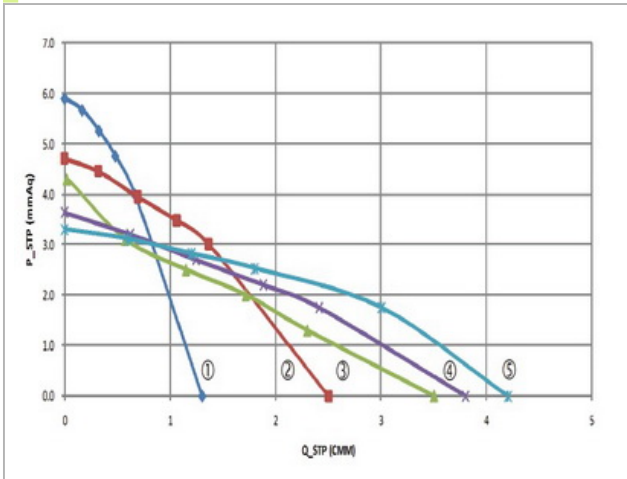

Performance

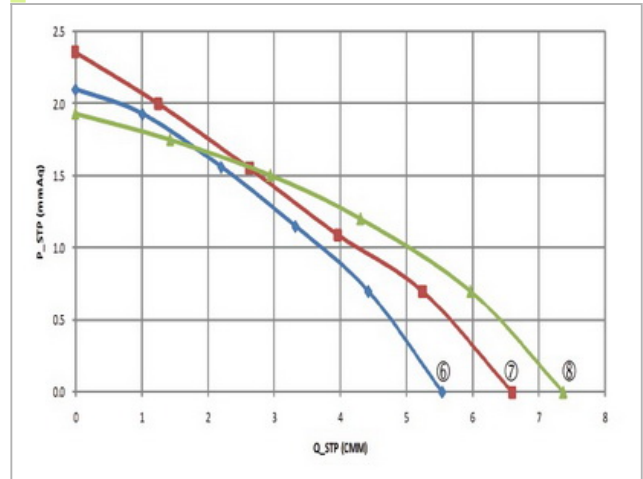

Dimensions:mm

Model	Spec.	Size(mm)			
		A	B	C	D
JE3-05009A24-3B	①	98	108	148	38
JE3-05019A24-3B	②	198	208	248	38
JE3-05029A24-3B	③	298	308	348	38
JE3-05035A24-3B	④	358	368	408	38
JE3-05042A24-3B	⑤	428	438	478	38
JF3-5029X2A24-3B	⑥	610	620	665	56
JF3-5035X2A24-3B	⑦	730	740	785	56
JF3-5042X2A24-3B	⑧	870	880	925	56

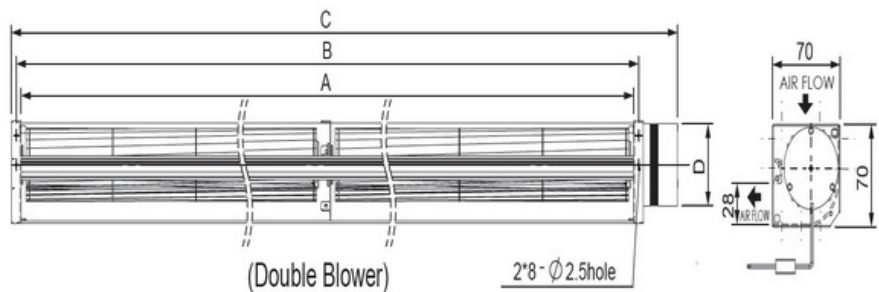

Specifications

Model NO.	Rated Voltage	Speed Airflow		Static Pressure	Current Noise Weight		
	VDC	RPM	M ³ /MIN	mmAq	A	dBA	g
JE3-05009A24-3B	24	2600	1.3	5.9	0.13	37	370
JE3-05019A24-3B	24	2500	2.5	4.7	0.31	43	470
JE3-05029A24-3B	24	2200	3.5	4.3	0.35	44	590
JE3-05035A24-3B	24	1800	3.8	3.7	0.26	36	660
JE3-05042A24-3B	24	1700	4.2	3.3	0.27	35	730
JF3-5029X2A24-3B	24	2050	5.5	2.1	0.45	40	1030
JF3-5035X2A24-3B	24	2000	6.6	2.4	0.47	40	1140
JF3-5042X2A24-3B	24	1950	7.4	1.9	0.53	39	1250

GULF ELECTRICS CO., LTD

Latest Product Information: www.gulf.com.tw/en
+886-7-5219966 ; service@gulf.com.tw



JM3-050A



General Specifications

Airflow	2.5~3.1 m ³ /min
Static Pressure	1.7~1.8 mmAq
Housing	ALUMINUM ALLOY
Blade	ALUMINUM ALLOY
Connecting	Wire Leads

Performance

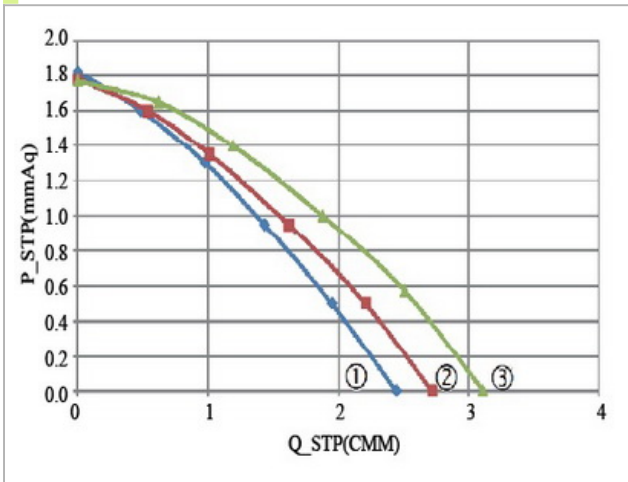

Dimensions:mm

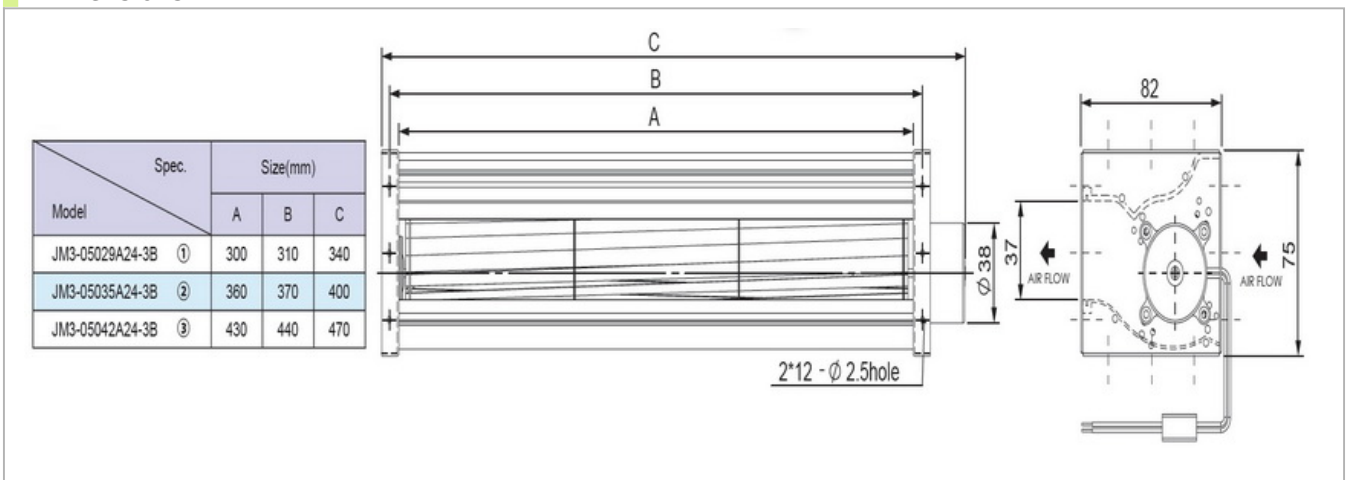

Specifications

Model NO.	Rated Voltage VDC	Speed Airflow		Static Pressure mmAq	Current Noise Weight		
		RPM	M ³ /MIN		A	dBA	g
JM3-05029A24-3B	24	2700	2.5	1.8	0.29	37	600
JM3-05035A24-3B	24	2600	2.7	1.8	0.30	38	660
JM3-05042A24-3B	24	2500	3.1	1.7	0.32	39	730



JH3-060A



General Specifications

Airflow	2.1~4.2 m3/min
Static Pressure	1.3~1.6 mmAq
Housing	Aluminum
Blade	ALUMINUM ALLOY
Connecting	Wire Leads

Performance

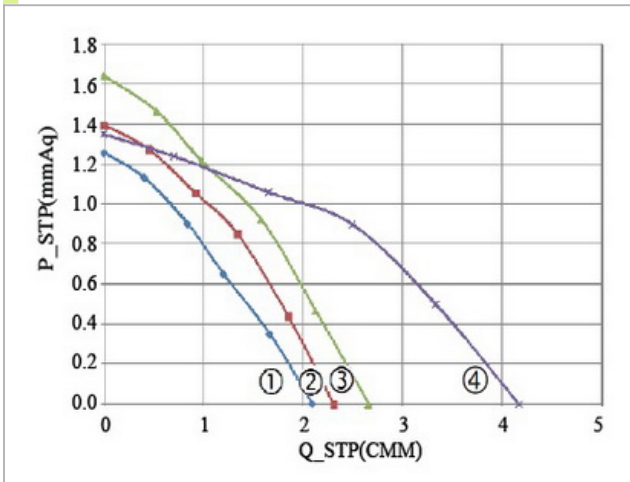

Dimensions:mm

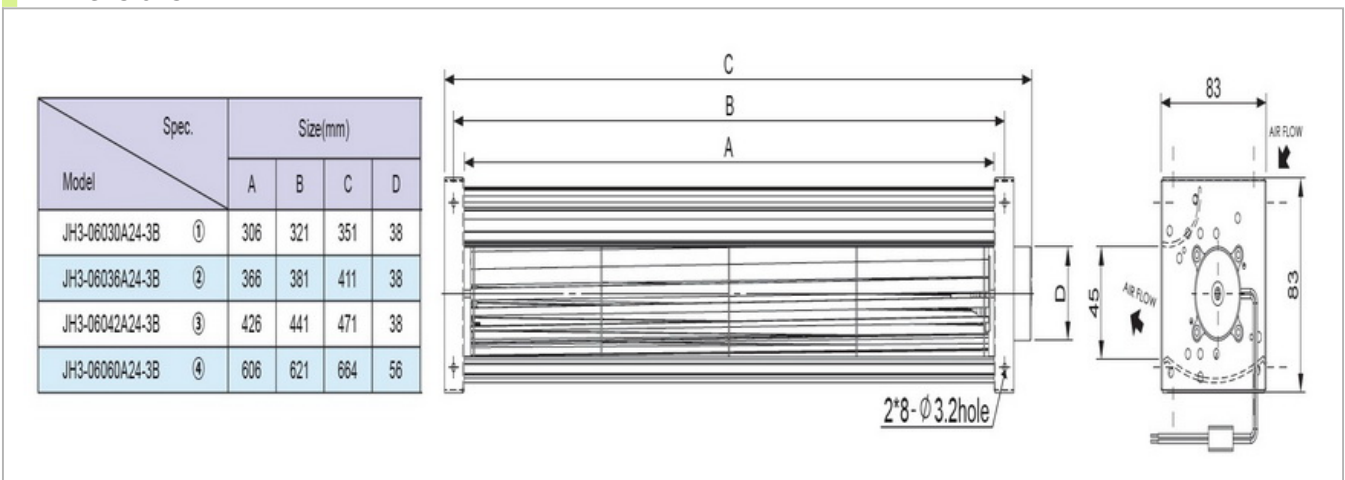

Specifications

Model NO.	Rated Voltage	Speed Airflow		Static Pressure	Current Noise Weight		
	VDC	RPM	M3/MIN		A	dBA	g
JH3-06030A24-3B	24	1900	2.1	1.3	0.26	35	680
JH3-06036A24-3B	24	1700	2.3	1.4	0.28	34	740
JH3-06042A24-3B	24	1600	2.7	1.6	0.29	33	810
JH3-06060A24-3B	24	1900	4.2	1.4	0.57	36	1260

GULF ELECTRICS CO., LTD

Latest Product Information: www.gulf.com.tw/en

+886-7-5219966 ; service@gulf.com.tw



JM3-060A



General Specifications

Airflow	2.4~3.8 m3/min
Static Pressure	1.1~1.7 mmAq
Housing	Aluminum
Blade	ALUMINUM ALLOY
Connecting	Wire Leads

Performance

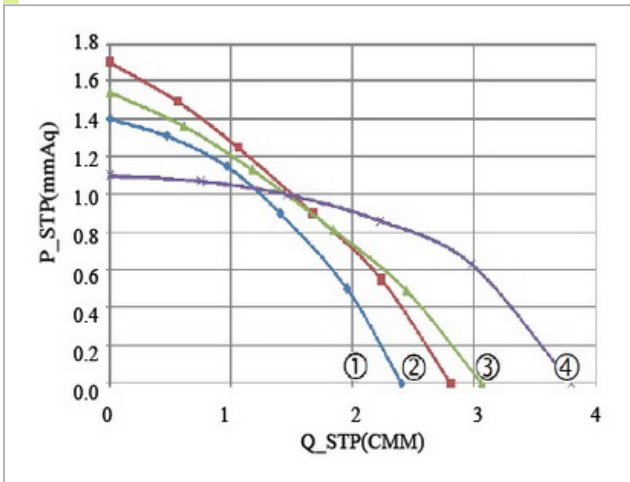

Dimensions:mm

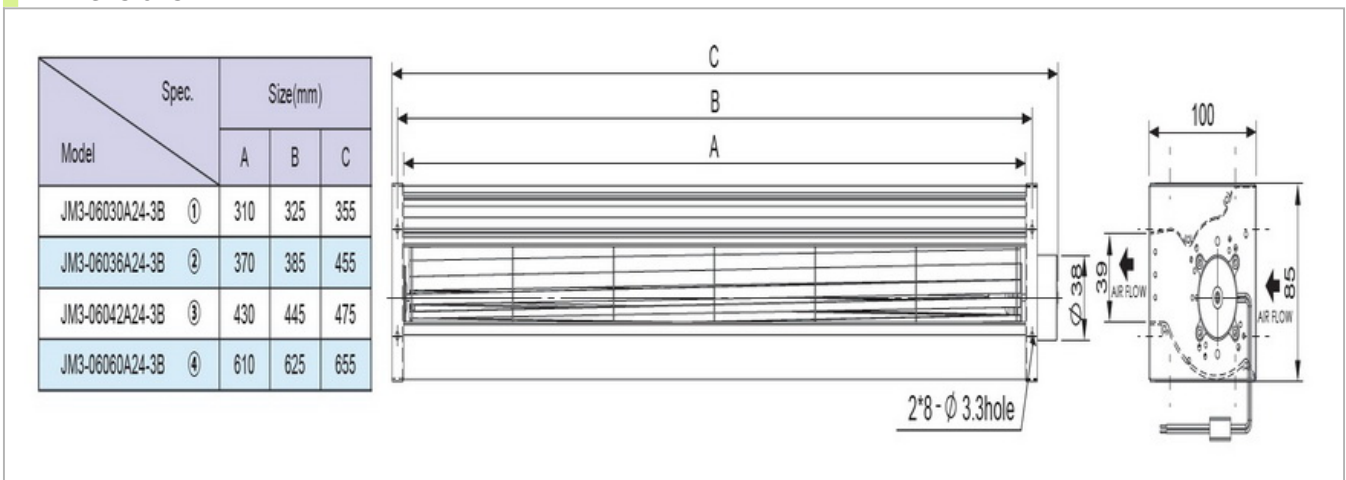

Specifications

Model NO.	Rated Voltage	Speed Airflow		Static Pressure	Current Noise Weight		
	VDC	RPM	M3/MIN	mmAq	A	dBA	g
JM3-06030A24-3B	24	1900	2.4	1.4	0.23	34	700
JM3-06036A24-3B	24	1850	2.8	1.7	0.25	33	770
JM3-06042A24-3B	24	1750	3.1	1.5	0.27	32	840
JM3-06060A24-3B	24	1550	3.8	1.1	0.30	31	900

GULF ELECTRICS CO., LTD

Latest Product Information: www.gulf.com.tw/en

+886-7-5219966 ; service@gulf.com.tw



JE3/JG3-060A



General Specifications

Airflow	1.9~8.3 m ³ /min
Static Pressure	2.5~4.4 mmAq
Housing	Black Zinc Electroplating
Blade	ALUMINUM ALLOY
Connecting	Wire Leads

Performance

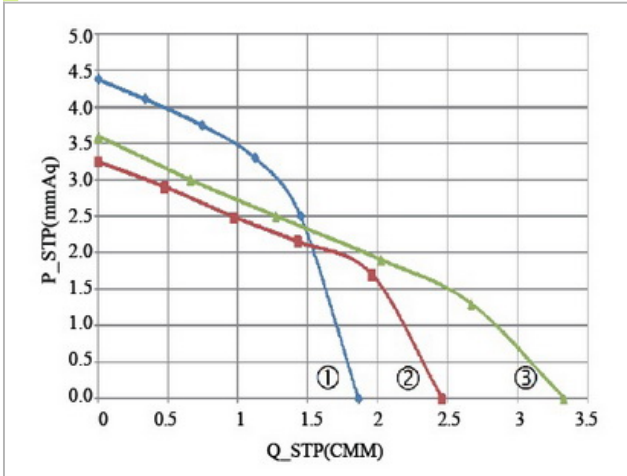

Performance

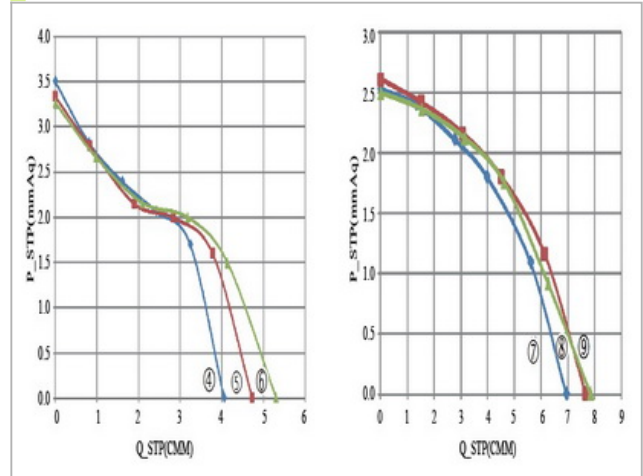

Dimensions:mm

Spec. Model	Size(mm)			
	A	B	C	D
JE3-06012A24-3B ①	124	139	168	38
JE3-06018A24-3B ②	184	199	228	38
JE3-06024A24-3B ③	245	260	305	56
JE3-06030A24-3B ④	305	320	365	56
JE3-06036A24-3B ⑤	365	380	425	56
JE3-06042A24-3B ⑥	425	440	485	56
JG3-06060A24-3B ⑦	610	625	670	56
JG3-6036X2A24-3B ⑧	750	765	810	56
JG3-6042X2A24-3B ⑨	870	885	930	56

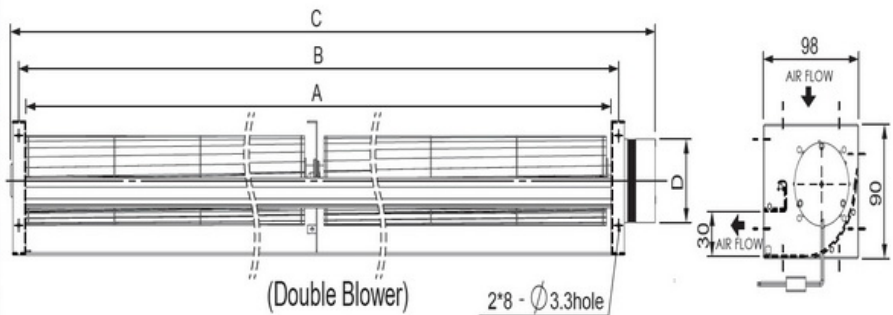

Specifications

Model NO.	Rated Voltage	Speed Airflow		Static Pressure	Current Noise Weight		
	VDC	RPM	M ³ /MIN	mmAq	A	dBA	g
JE3-06012A24-3B	24	2500	1.9	4.4	0.35	44	500
JE3-06018A24-3B	24	2200	2.5	3.2	0.40	42	580
JE3-06024A24-3B	24	2100	3.3	3.6	0.42	41	850
JE3-06030A24-3B	24	2000	4.1	3.5	0.46	41	930
JE3-06036A24-3B	24	1950	4.7	3.4	0.51	40	1000
JE3-06042A24-3B	24	1900	5.3	3.3	0.53	40	1080
JG3-06060A24-3B	24	1650	6.9	2.5	0.63	39	1250
JG3-6036X2A24-3B	24	1700	7.7	2.6	0.69	40	1420
JG3-6042X2A24-3B	24	1600	8.3	2.5	0.78	41	1550

GULF ELECTRICS CO., LTD

Latest Product Information: www.gulf.com.tw/en
+886-7-5219966 ; service@gulf.com.tw



JE3-060B



General Specifications

Airflow	7.5~9.3 m3/min
Static Pressure	8.1~10.0 mmAq
Housing	Black Zinc Electroplating
Blade	ALUMINUM ALLOY
Connecting	Wire Leads

Performance

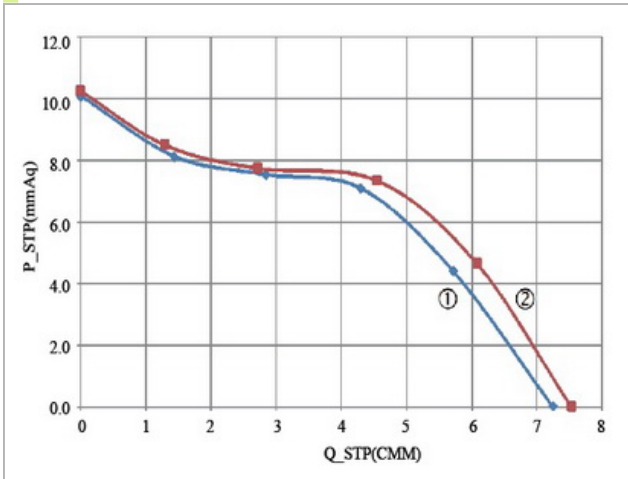

Performance

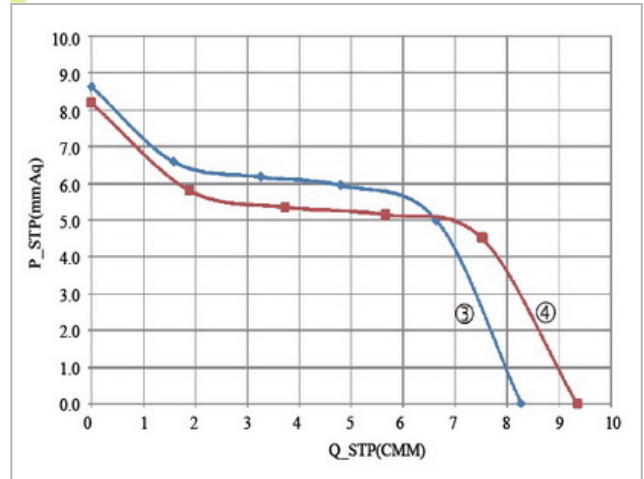

Dimensions:mm

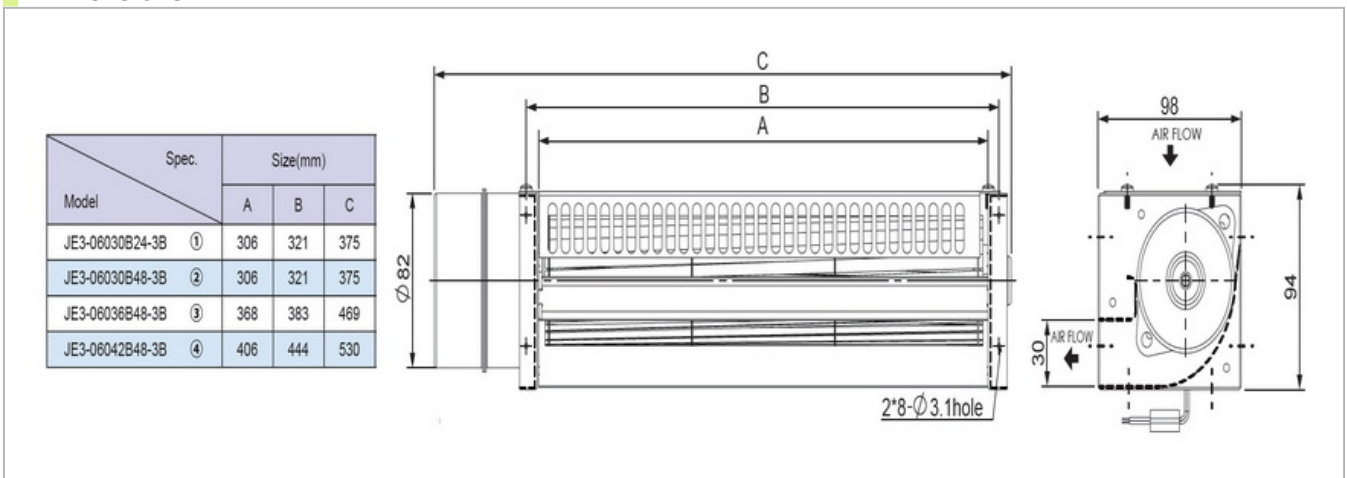

Specifications

Model NO.	Rated Voltage VDC	Speed Airflow		Static Pressure mmAq	Current Noise Weight		
		RPM	M3/MIN		A	dBA	KG
JE3-06030B24-3B	24	3500	7.5	10.0	2.3	62	1.4
JE3-06030B48-3B	48	3500	7.5	10.0	1.0	62	1.4
JE3-06036B48-3B	48	3300	8.2	8.6	1.1	60	1.6
JE3-06042B48-3B	48	3150	9.3	8.1	1.1	60	1.8



JQF3-060A



General Specifications

Airflow	1.8~5.6 m ³ /min
Static Pressure	5.3~6.4 mmAq
Housing	Zinc
Blade	ALUMINUM ALLOY
Connecting	Wire Leads

Performance

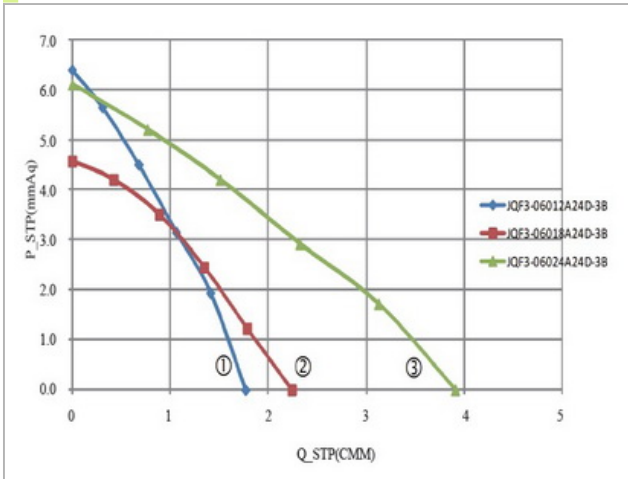

Performance

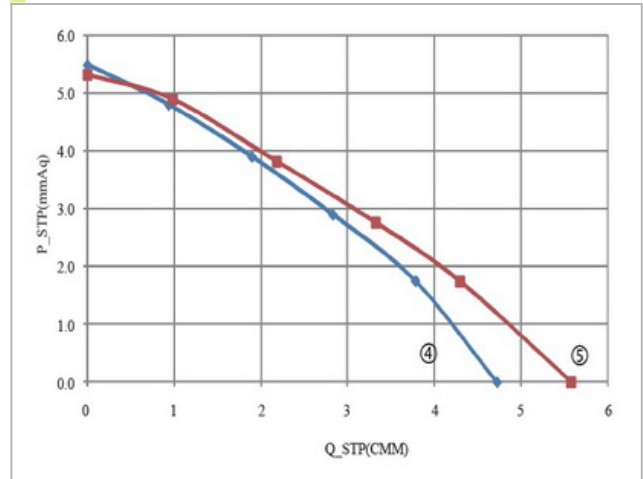

Dimensions:mm

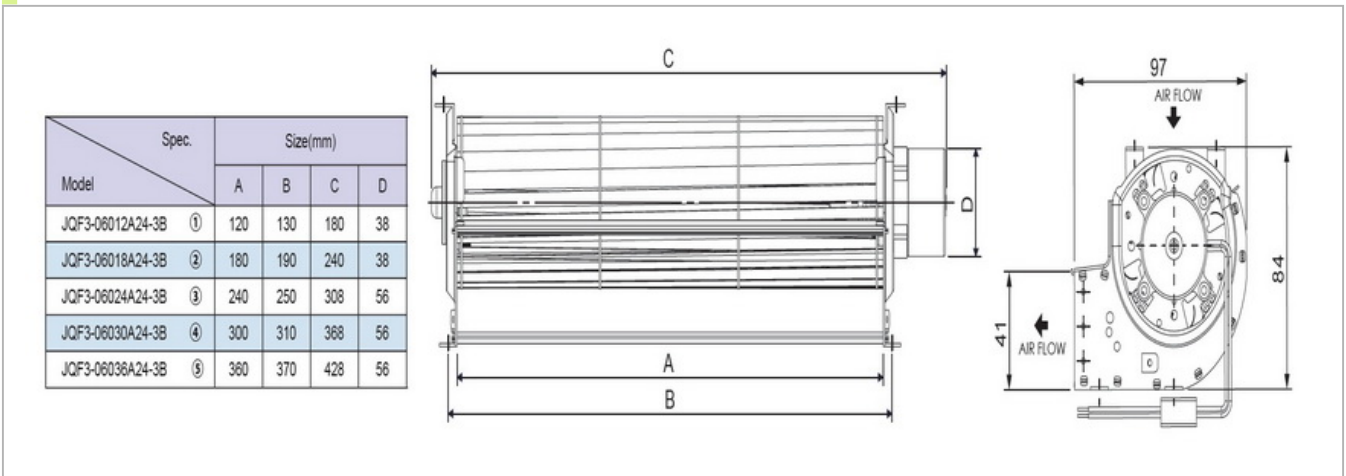

Specifications

Model NO.	Rated Voltage VDC	Speed Airflow		Static Pressure mmAq	Current Noise Weight		
		RPM	M ³ /MIN		A	dBA	g
JQF3-06012A24-3B	24	2000	1.8	6.4	0.24	39	400
JQF3-06018A24-3B	24	1600	2.2	4.6	0.28	36	570
JQF3-06024A24-3B	24	2000	3.9	6.1	0.51	44	790
JQF3-06030A24-3B	24	1850	4.7	5.5	0.59	45	860
JQF3-06036A24-3B	24	1750	5.6	5.3	0.66	47	950

GULF ELECTRICS CO., LTD

Latest Product Information: www.gulf.com.tw/en
+886-7-5219966 ; service@gulf.com.tw



JQ3-065A



General Specifications

Airflow	2.2~5.1 m ³ /min
Static Pressure	2.3~2.8 mmAq
Housing	Zinc
Blade	ALUMINUM ALLOY
Connecting	Wire Leads

Performance

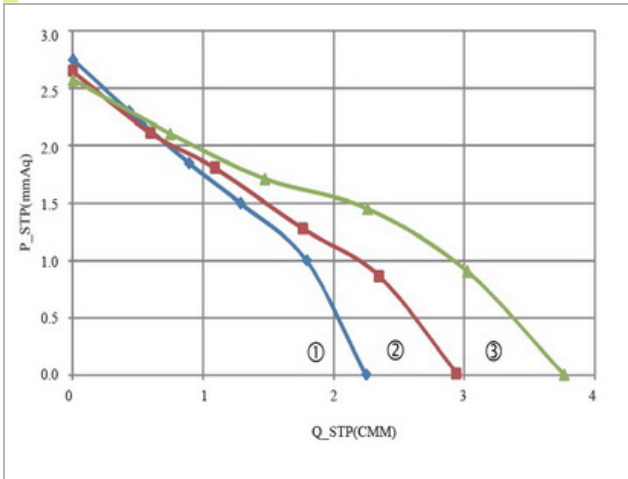

Performance

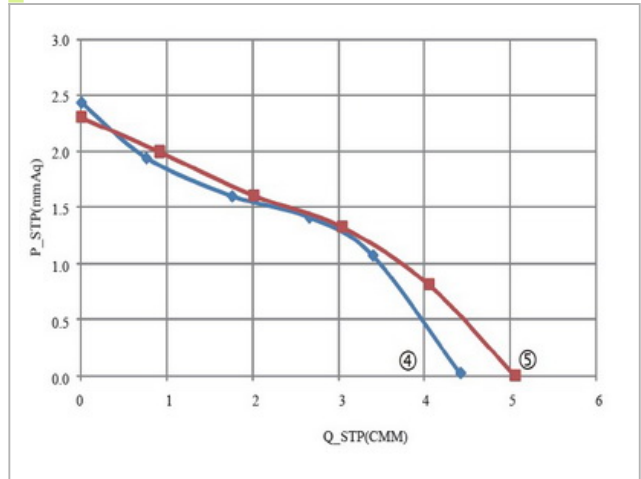

Dimensions:mm

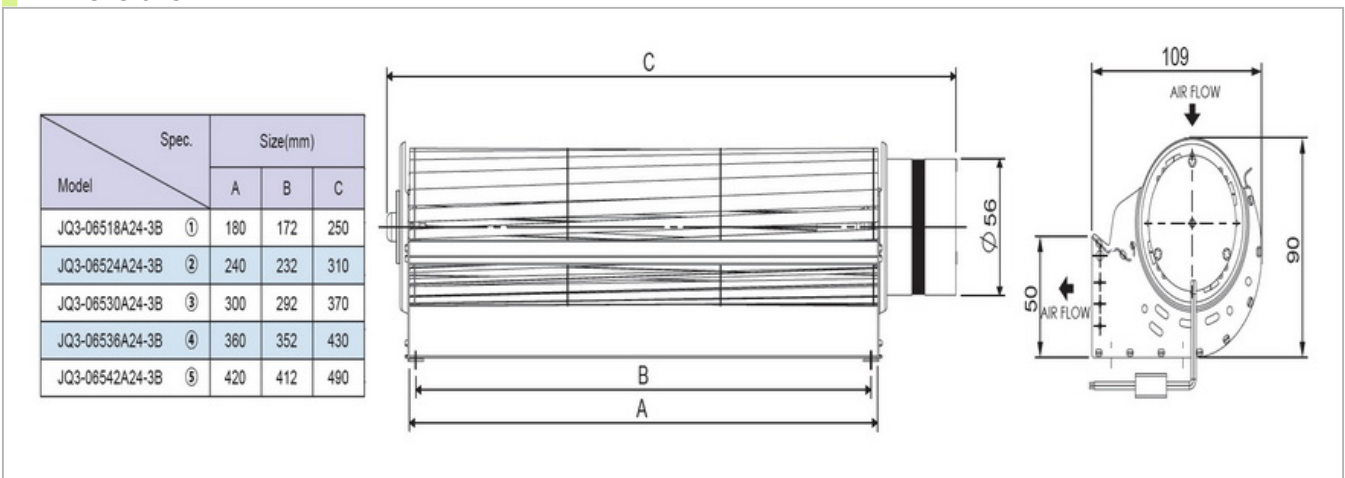

Specifications

Model NO.	Rated Voltage VDC	Speed Airflow		Static Pressure mmAq	Current Noise Weight		
		RPM	M ³ /MIN		A	dBA	g
JQ3-06518A24-3B	24	1400	2.2	2.8	0.20	34	740
JQ3-06524A24-3B	24	1300	2.9	2.7	0.23	35	810
JQ3-06530A24-3B	24	1250	3.8	2.6	0.27	36	930
JQ3-06536A24-3B	24	1200	4.4	2.4	0.29	38	1050
JQ3-06542A24-3B	24	1150	5.1	2.3	0.32	37	1110

GULF ELECTRICS CO., LTD

Latest Product Information: www.gulf.com.tw/en
+886-7-5219966 ; service@gulf.com.tw



JF3-065A



General Specifications

Airflow	9.6~11.5 m ³ /min
Static Pressure	4.2~4.7 mmAq
Housing	Aluminum
Blade	ALUMINUM ALLOY
Connecting	Wire Leads

Performance

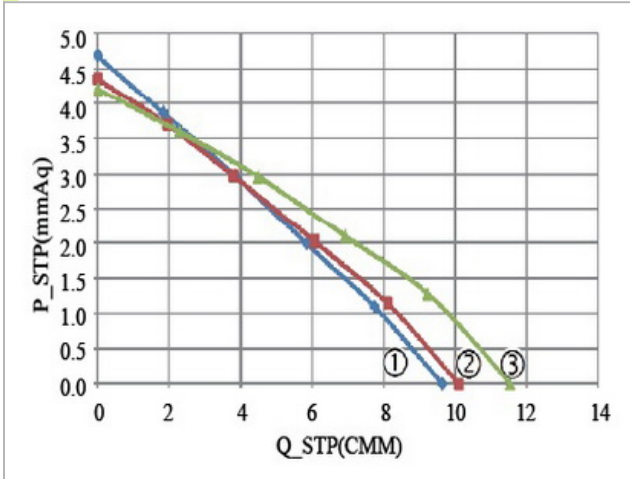

Dimensions:mm

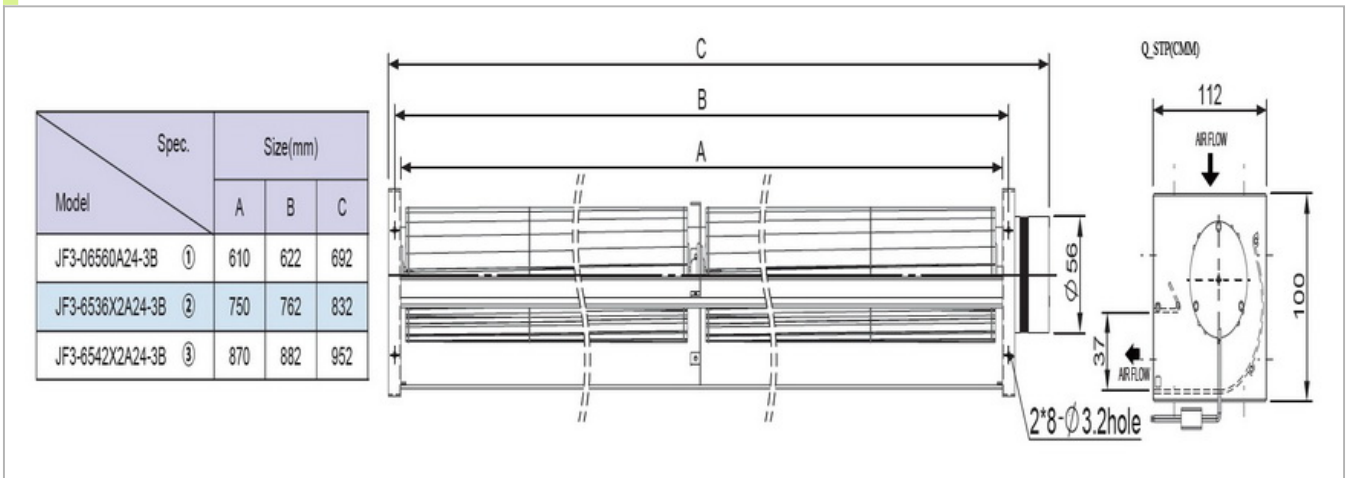

Specifications

Model NO.	Rated Voltage VDC	Speed Airflow		Static Pressure mmAq	Current Noise Weight		
		RPM	M ³ /MIN		A	dBA	KG
JF3-06560A24-3B	24	1750	9.6	4.7	0.89	48	1.45
JF3-06536X2A24-3B	24	1650	10.1	4.4	0.93	47	1.65
JF3-6542X2A24-3B	24	1550	11.5	4.2	1.02	46	1.80



JH3-081A



General Specifications

Airflow	7.2~11.0 m ³ /min
Static Pressure	3.0~3.5 mmAq
Housing	Aluminum
Blade	ALUMINUM ALLOY
Connecting	Wire Leads

Performance

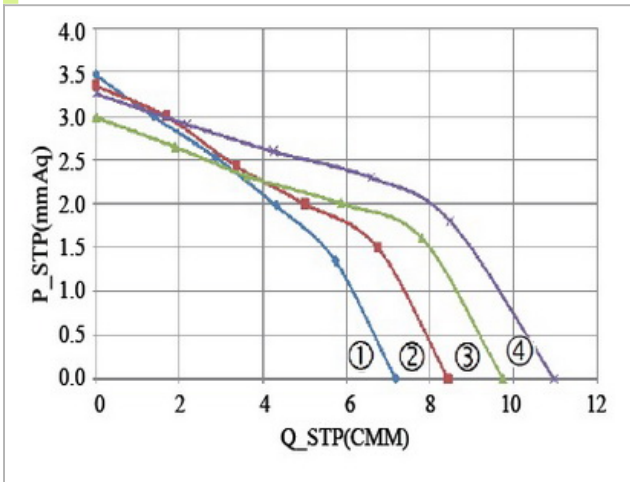

Dimensions:mm

Model	Spec.	Size(mm)			
		A	B	C	D
JH3-08142A24-3B	①	420	440	507	56
JH3-08150A24-3B	②	500	520	587	56
JH3-08160A24-3B	③	600	620	687	56
JH3-08170A24-3B	④	700	720	790	82

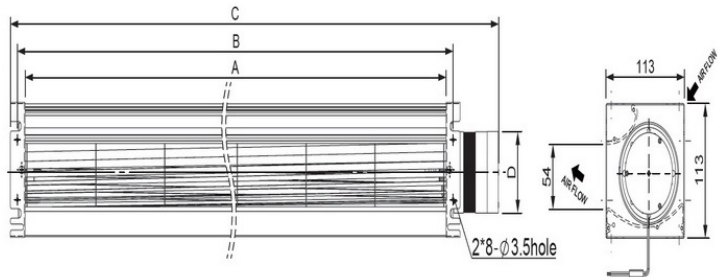

Specifications

Model NO.	Rated Voltage	Speed Airflow		Static Pressure	Current Noise Weight		
	VDC	RPM	M ³ /MIN		A	dBA	KG
JH3-08142A24-3B	24	1850	7.2	3.5	1.55	51	1.65
JH3-08150A24-3B	24	1700	8.4	3.4	1.75	48	1.80
JH3-08160A24-3B	24	1600	9.7	3.0	1.85	46	1.95
JH3-08170A24-3B	24	1700	11.0	3.3	2.10	48	2.60



JF3-081A



General Specifications

Airflow	10.4~18.3 m ³ /min
Static Pressure	5.5~6.2 mmAq
Housing	Aluminum
Blade	ALUMINUM ALLOY
Connecting	Wire Leads

Performance

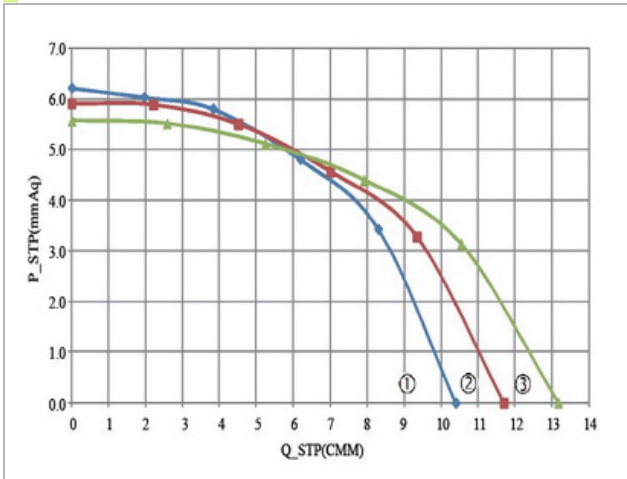

Performance

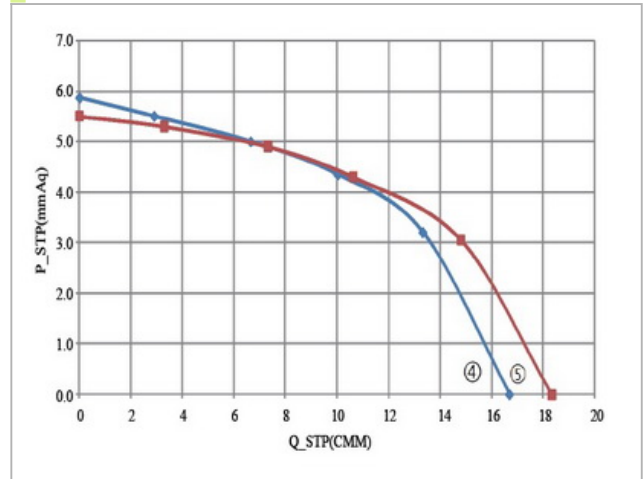

Dimensions:mm

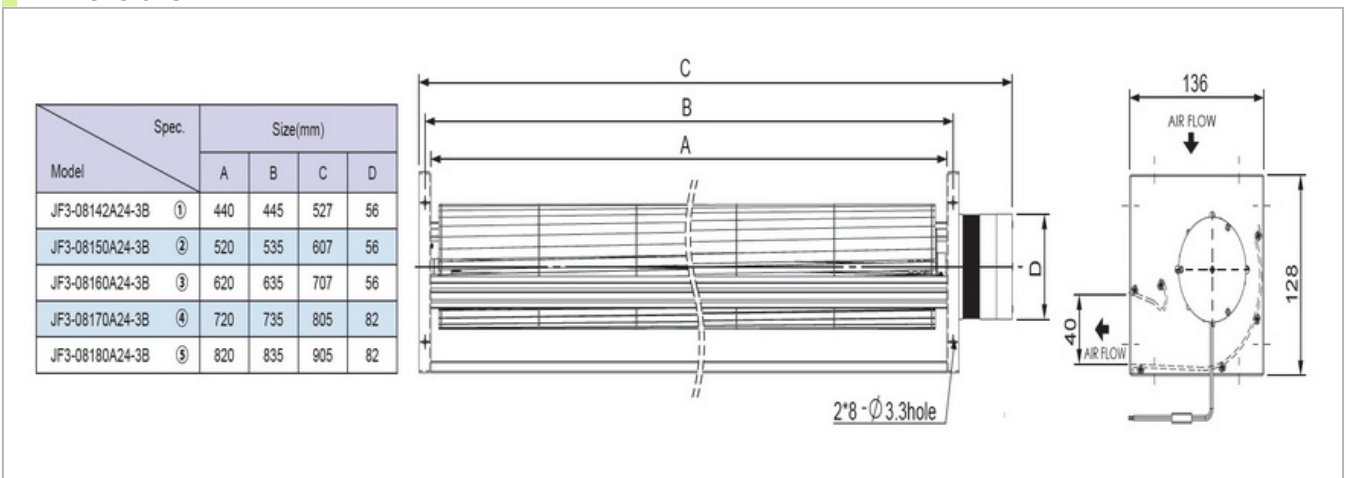

Specifications

Model NO.	Rated Voltage VDC	Speed Airflow		Static Pressure mmAq	Current Noise Weight		
		RPM	M ³ /MIN		A	dBA	KG
JF3-08142A24-3B	24	1650	10.4	6.2	1.85	53	1.90
JF3-08150A24-3B	24	1500	11.7	5.8	1.95	52	2.05
JF3-08160A24-3B	24	1400	13.2	5.5	2.10	51	2.25
JF3-08170A24-3B	24	1500	16.7	5.8	2.30	52	2.90
JF3-08180A24-3B	24	1400	18.3	5.5	2.35	51	3.05

GULF ELECTRICS CO., LTD

Latest Product Information: www.gulf.com.tw/en
+886-7-5219966 ; service@gulf.com.tw

